

FACILITIES BASKETBALL VOLLEYBALL SOCCER FOOTBALL

EQUIPMENT COLLECTION

PORTERATHLETIC.COM

2023

porter®



FIELD HOUSE



HIGH VOLUME



GYMNASIUM



**MULTI-SPORT
ADAPTABILITY**



**TOURNAMENT
QUICK TURN OVER**



**COMPETITION
DURABILITY**

EVERY FACILITY IS UNIQUE

Decide which is the best fit for yours.

WE DO IMPOSSIBLE.

Planning a standout sports facility that's made to last and flexible enough to do it all is a challenge we meet every day. Whether that's a high volume athletic center, a community recreation facility, or a school gymnasium, facility equipment is no longer just about the mechanical, but also how new technologies and responsiveness can improve the customer experience.

Partner with Porter and build on 150 years of elevating every sport we serve.

porter[®]

PORTER 2021 EQUIPMENT COLLECTION

porter®

RAPIDLIFT®

WHEN FAST MATTERS

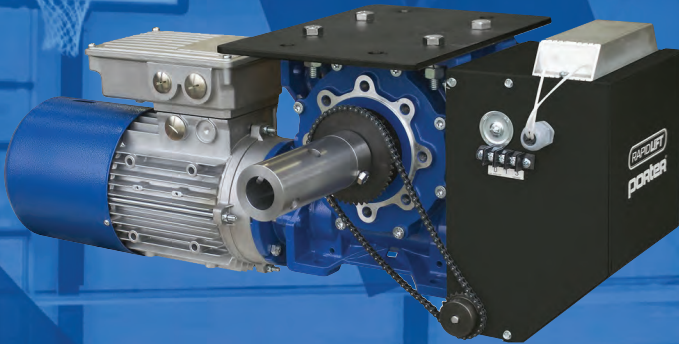

Curtain Winch

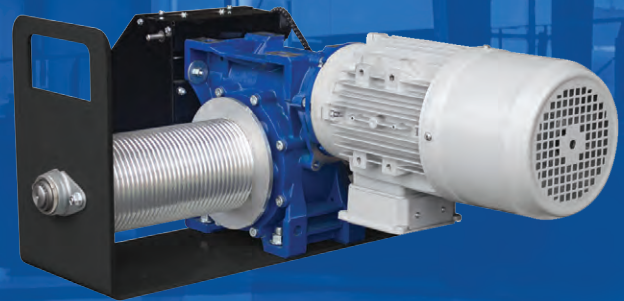

Backstop Winch

Whether you need curtains, backstops, or both, if your facility is hosting multiple back-to-back events, the NEW Porter RAPIDLIFT® can help turnover the next activity up to 3x faster. See page 62.



FACILITIES OF ANY SIZE



30+ FT/MIN SPEED

WE DO IMPOSSIBLE.

2023 EQUIPMENT

COLLECTION CATALOG

WHAT'S INSIDE

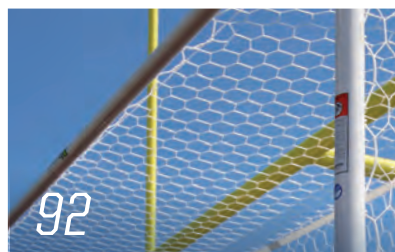
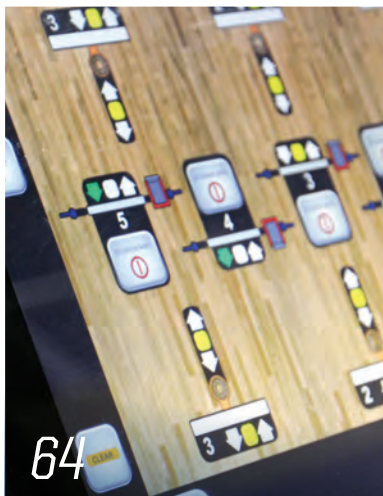
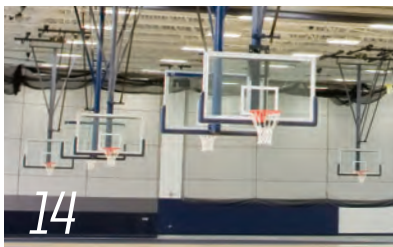
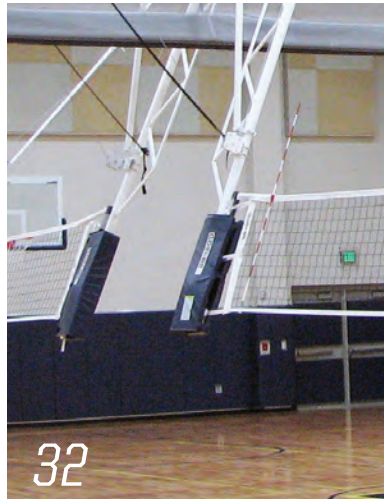

06 BASKETBALL

- 06 Portables & Accessories
- 14 Center-Strut Series
- 16 Wall Mount Backstops
- 17 Height Adjusters
- 18 Winches & Accessories
- 20 Backboards
- 22 Goals
- 24 Accessories
- 26 Gooseneck Systems
- 28 Vertical Post Systems
- 30 Adjustable & Outdoor Systems

32 VOLLEYBALL

- 32 POWR-Net Overhead System
- 34 POWR-Series Standards
- 40 Recreational Standards
- 42 Net & Accessories
- 44 Upright Padding & Graphics
- 46 Judge's Stands & Accessories
- 48 Sleeves, Plates & Anchors
- 49 Game Standards

52 INDOOR FACILITIES

- 52 Divider Curtains
- 60 Indoor Cages
- 62 Winches & Controls
- 68 Mat Mover & Floor Covering
- 70 Gym Equipment & Ropes
- 72 Indoor Specialty Pads

76 OUTDOOR FACILITIES

- 76 Hammer & Discus Cages
- 80 Circles & Toeboards
- 81 Take-Off Boards & Vault Boxes
- 82 Sandpits
- 84 Ball Stops
- 85 Shelters & Versacom Boxes
- 86 Benches & Bleachers

88 FOOTBALL

- 88 Football Goals
- 90 Football Padding & Specialty Goals

92 SOCCER

- 92 Soccer Goals
- 96 Security Anchors & Sleeves

97 LACROSSE & FIELD HOCKEY

- 97 Lacrosse, Field Hockey & Futsal Goals

98 TENNIS

- 98 Tennis Posts & Nets

99 BASEBALL

- 99 Windscreens
- 100 Bases, Dugouts, & Foul Poles

102 PADDING & TUNNELS

- 102 Outdoor Padding
- 104 Outdoor Batting Tunnels & Cages

At Porter Athletic, our mission is to continually improve our processes, products, expertise, and service to create superior opportunities for athletic success.





**WE DO
IMPOSSIBLE.**



COURT SPORTS

1835 PORTABLE BACKSTOPS

6

MOTORIZED BACKSTOP OPTIONS

- 1835108MCXXYY 10'8" (3.25m) Extension
- 1835080MCXXYY 8' (2.44m) Extension

MANUAL BACKSTOP OPTIONS

- 1835108CXXYY 10'8" (3.25m) Extension
- 1835080CXXYY 8' (2.44m) Extension

CUSTOMIZE

- 1834CXX Boom Pad
- 183830 Mast Mount Shot Clock Support
- 183850 Platform Mount Shot Clock Support
- 183860 Rear Shot Clock Support
- Page 24 Perimeter Backboard Lights
- Page 13 Replacement Pads
- Page 13 Graphic Pad Set
- Page 12 Floor Anchor Extension Bracket



Each Portable Unit Includes:



Center-Strut Glass Backboard



Pro-Pad Bolt-On Backboard Padding



TFX Goal with Anti-Whip Net



Exclusive Self-Docking Anchor Trays (Patent No. 10,238,944)



Floor Anchors

1835 Dimensions

	1835108	1835080
A	10'8"	8'
B	6'8"	4'
IN STORAGE		
(H)	7'3"	7'1"
(L)	15'1"	13'10"
(W)	6'4"	6'4"

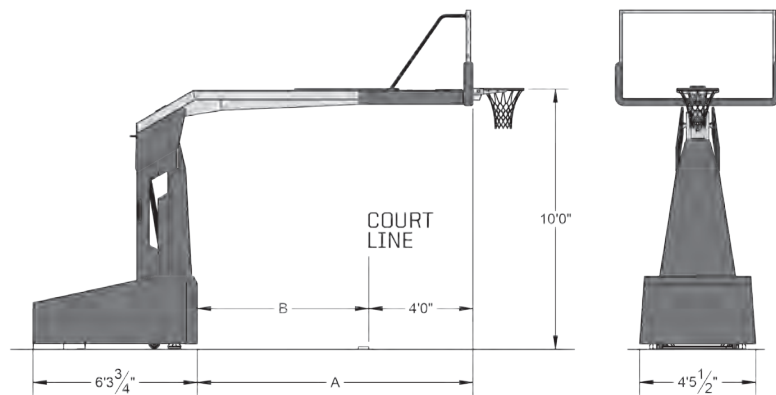

Vinyl Colors: (xx)

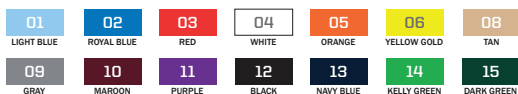

Powder Coat Colors: (yy)





Portable Shown With Optional Shot Clock Support



CUSTOM GRAPHICS AVAILABLE



1835 SERIES

Satisfy the highest levels of competition and performance with the new arena-level portable from Porter, and eliminate the universal pains previously experienced with portable backstops.

The 1835 portable offers breakthroughs in the installation and setup process. Porter's exclusive self-docking tray anchor system (Patent No. 10,238,944) allows perfect alignment into a secured game position, eliminating hassles. Special locator pins provide additional control and user support during the setup process. Once positioned, the 1835 portable offers effortless spring-assisted setup for play.

Meticulously crafted protective pads integrate perfectly around the base and stanchion of the portable to enhance facility appearance. Choose from a full-range of vinyl pad colors and vibrant powder coat frame colors to complete your

portable design. Optional full-color protective pad graphics offer

- EXCLUSIVE SELF-DOCKING ANCHOR TRAY (Patent No. 10,238,944)
- AUTO-RETRACTABLE FOOT PAD
- DROP PIN LOCATING SYSTEM
- INTEGRATED PLUMBING AND LEVELING
- 4" THICK FRONT PADDING
- AVAILABLE IN 8' AND 10'8" EXTENSIONS
- ADJUSTABLE TO 8', 9', AND 10' GOAL HEIGHTS

 **10 YEAR LIMITED WARRANTY**



meets requirements for **NCAA NFHS**



1135 PORTABLE BACKSTOPS

BACKSTOP OPTIONS

- 1135080CXXYY** Manual 8' (2.44m) Extension
- 1135080BCXXYY** Extra Ballast Manual 8' (2.44m) Extension
**Floor Anchors Not Required for Extra Ballast Backstops*

CUSTOMIZE

- 1134CXX** Boom Pad
- 113130** Mast Mount Shot Clock Support
- 113150** Platform Mount Show Clock Support
- See page 24 Perimeter Backboard Lights
- See page 13 Replacement Pads
- See page 13 Graphic Pad Set
- FITG00300** Locator Cup Kit



+ Locator Cup Kit (Optional)



*Torq-Flex Competition Goal Shown

Each Portable Unit Includes:



Center-Strut Glass Backboard



Pro-Pad Bolt-On Backboard Padding



Torq-Flex Competition Goal with Anti-Whip Net



Floor Anchors

1135 Dimensions

1135080	
A	8'
B	4'
IN STORAGE	
(H)	6'8"
(L)	13'7"
(W)	6'4"

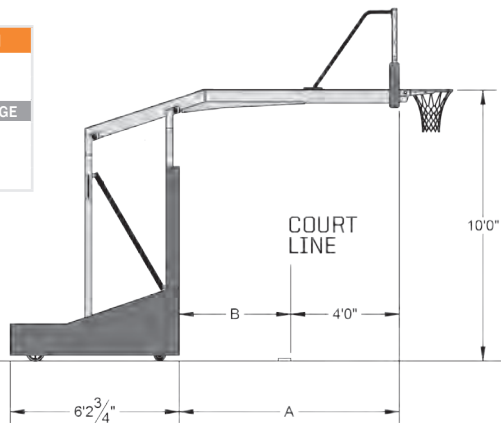

Vinyl Colors: (xx)

01 LIGHT BLUE	02 ROYAL BLUE	03 RED	04 WHITE	05 ORANGE
06 YELLOW GOLD	08 TAN	09 GRAY	10 MAROON	11 PURPLE
12 BLACK	13 NAVY BLUE	14 KELLY GREEN	15 DARK GREEN	

Powder Coat Colors: (yy)

01 LIGHT BLUE	02 ROYAL BLUE	03 RED	04 WHITE	05 ORANGE
06 YELLOW GOLD	07 SILVER	08 OLD GOLD	09 GRAY	10 MAROON
11 PURPLE	12 BLACK	13 NAVY BLUE	14 KELLY GREEN	15 DARK GREEN



Portable Shown With Optional Shot Clock Support



CUSTOM GRAPHICS AVAILABLE



1135 SERIES

This versatile portable backstop combines high-level play capability with simplified storage and maneuvering capabilities.

We are proud to introduce the 1135 to the Porter Athletic Portable lineup. The 1135 unit is a spring assisted, folding portable that provides extra stability and meets all competition needs.

The 1135 is anchored and secured with two heavy duty threaded rods that screw into specially designed floor anchors. Two leveling feet in the front of the unit allow for precision adjustment of the height setting and provide stability for the unit. The 1135 features Porter's Center-Strut direct goal attachment, allowing for easy goal and backboard installation. The direct goal-mount system also withstands slam-dunk action and prevents glass backboards from shattering. This portable is more easily stored and maneuvered than traditional arena competition portables. The 1135 is guided by two rigid, dual-wheel casters and two swivel casters.

- CENTER-STRUT ATTACHMENT
- THREADED KNOB TIE-DOWN SYSTEM
- SCREW-TYPE LEVELING JACKS
- 6 NON-MARKING RUBBER CASTER WHEELS
- 2" THICK FRONT PADDING (7' TALL)
- ADJUSTABLE TO 8', 9', AND 10' GOAL HEIGHTS

 **10** YEAR LIMITED WARRANTY



meets requirements for
NCAA NFHS

735 PORTABLE BACKSTOPS

10

BACKSTOP OPTIONS

- 735050CXXYY** Manual 5' (1.52m) Extension
- 735050BCXXYY** Extra Ballast Manual 5' (1.52m) Extension
*Floor Anchors Not Required for Extra Ballast Backstops

CUSTOMIZE

- 007375** Shot Clock Support
- See page 24 Perimeter Backboard Lights
- See page 13 Replacement Pads
- See page 13 Graphic Pad Set
- FITG00300** Locator Cup Kit
- FITG0047X** Floor Anchor Kit

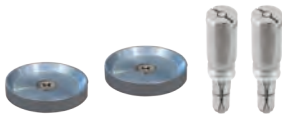

+ Locator Cup Kit (Optional)



Each Portable Unit Includes:



Center - Strut Glass Backboard



Pro-Pad Bolt-On Backboard Padding



Ultra-Breakaway Competition Goal with Anti-Whip Net



+ Floor Anchor Kit (Optional)

735 Dimensions

	735050
A	5'
STORAGE	
(H)	6'7"
(L)	11'10"
(W)	6'4"

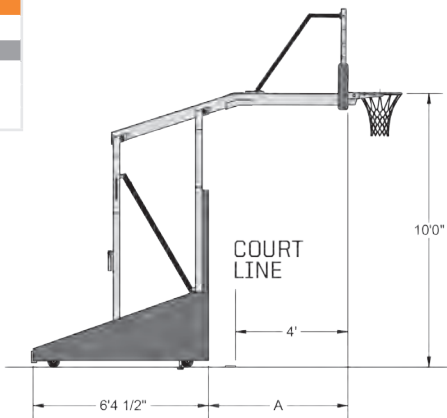

Vinyl Colors: (xx)

01 LIGHT BLUE	02 ROYAL BLUE	03 RED	04 WHITE	05 ORANGE
06 YELLOW GOLD	08 TAN	09 GRAY	10 MAROON	11 PURPLE
12 BLACK	13 NAVY BLUE	14 KELLY GREEN	15 DARK GREEN	

Powder Coat Colors: (yy)

01 LIGHT BLUE	02 ROYAL BLUE	03 RED	04 WHITE	05 ORANGE
06 YELLOW GOLD	07 SILVER	08 OLD GOLD	09 GRAY	10 MAROON
11 PURPLE	12 BLACK	13 NAVY BLUE	14 KELLY GREEN	15 DARK GREEN



Portable Shown With Optional Shot Clock Support



CUSTOM GRAPHICS
AVAILABLE

735 SERIES

New-and-improved design features make this portable a top choice for both competitive team practices and recreational play.

A unique tension spring assist folding mechanism concealed in the base provides instant and effortless height adjustments from storage position to 8' 9" or 10' goal heights. An improved anchoring method includes one tie-down threaded anchor at the rear position and two screw-type level jacks in the front for simplified setup. Updated frame and boom construction provides maximum durability.

Porter's Center-Strut direct goal-mount system withstands slam dunking and prevents glass backboards from shattering.

- **SPRING OPERATED**
- **SCREW-TYPE LEVELING JACKS**
- **THREADED KNOB TIE-DOWN SYSTEM**
- **UPDATED FRAME AND BOOM**
- **2" THICK FRONT PADDING**
- **4 NON-MARKING SWIVEL CASTER WHEELS**
- **ADJUSTABLE TO 8', 9', AND 10' GOAL HEIGHTS**

 **10** YEAR LIMITED WARRANTY



PORTABLE ACCESSORIES

12



1835 Floor Extension Bracket

Optional tie down bracket recommended for portable floor with less than 4' from the edge of the floor to the rear of the portable. Includes bracket, chain, and anchor.

FITG00430



Floating Floor Type Anchor

Two part system to allow movement and expansion of wood floor where flooring does not exceed 3⁷/₈" total thickness. Anchor installs after finished floor is in place by means of a double acting masonry anchor. 5" chrome or brass plated cover assembly consists of molded plastic recessed mounting flange, cork gasket and swivel type retainer pin. Specify extended shaft handwheel for use on floor mounted equipment.

00249000

00249200

HAND00001000

HAND000027000

HAND000067000

Anchor w/ Chrome Cover

Anchor w/ Brass Cover

Handwheel w/Stud 1/2"-3 1/2"

Handwheel w/Stud 1/2"-2 1/4"

Handwheel w/Stud 1/2"-4"



Sleeper Anchor

Designed for use in sleeper floors where anchorage into both concrete slab and wood floor is desirable. Top plate is 3 1/2" diameter and is threaded to provide adjustment to floor surface.

00244000



Portable Floor Type Anchor

Designed specifically for installation on a professional type portable wood flooring system. Anchor is identical to the 3 1/2" diameter chrome plated top plate assembly as used on the No. 00242100 floor anchor with the addition of flat head machine screws and a heavy steel reinforcing plate which is mounted under the portable floor panels to properly distribute loading on the wood sections.

00242900



Expansion Anchor

The industry's favorite. Ideal where there is at least 6" of concrete. Expansion shield provides super holding power. Anchor is 1 1/2" diameter minimizing metal surface on gym floor. Top portion of anchor may be removed for cleaning and washers may be added or removed to keep surface of anchor flush with floor.

00247100



Thin Concrete Anchor

Designed for maximum holding power through thin channel lock wood or synthetic floors into concrete sub-floors of minimal thickness. Four double acting expansion anchors provide an ultimate pull-out load of 8,200 pounds when properly installed. Top plate is 3 1/2" diameter and is polished and chrome plated.

00242100

CUSTOM GRAPHICS

Give your school or facility a true home team advantage with custom printed graphics on your portable backstop!

Simply provide your logo artwork and our design team works with you to create a stunning display. With a state-of-the-art printing process and proper artwork our printer can print nearly any design!

Custom Graphics Add **SP** to end of portable item #



LOOK FOR
THIS ICON

Visit PorterAthletic.com
to find your replacement parts and pads.

900 CENTER-STRUT BACKSTOPS

900 Series Folding Options.

BACKSTOP OPTIONS

14

FORWARD FOLDING

- 917 Rear Braced
- 949 Front Braced
- 950 Front Braced / Bent Mast

BACKWARD FOLDING

- 923 Rear Braced
- 951 Rear Braced / Trak Fold
- 952 Rear Braced / Bent Mast

SIDE FOLDING

- 955 Side Braced
- 956 Side Braced / Bent Mast

STATIONARY

- 918 Wall Braced
- 926 Ceiling Braced

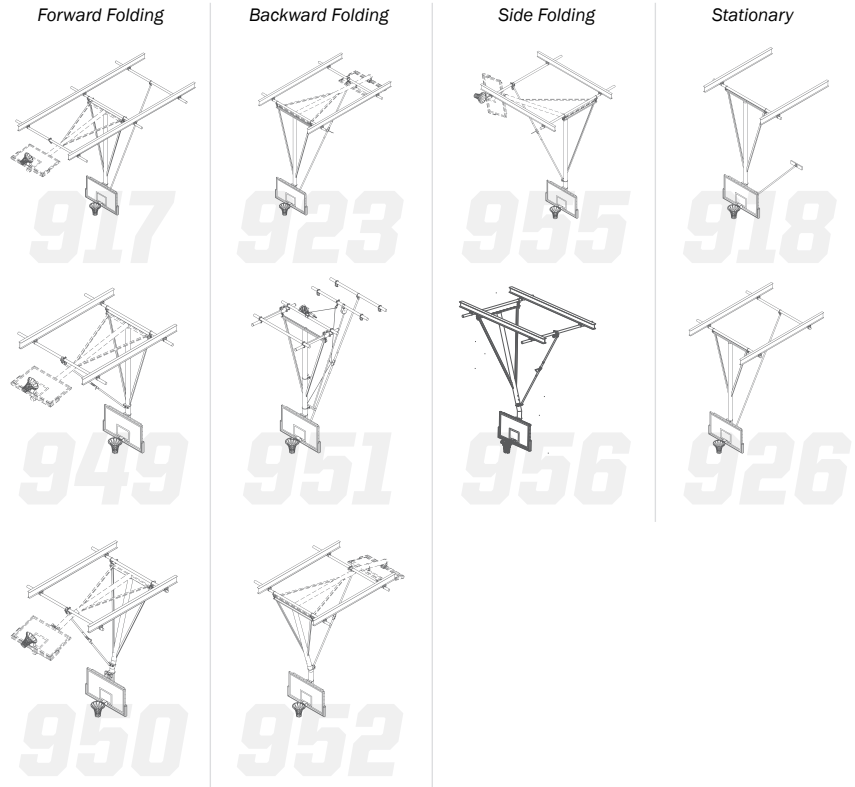

Center Strut Features:



Center-Strut mounts directly to the 6 5/8" diameter vertical drop frame support.



The glass backboard mounts to Center-Strut goal support with two independent bolts to provide Porter's exclusive backboard/goal mounting system.



Goal mounts independently with four bolts extending through the backboard and into the Center-Strut mounting plate to eliminate any stress on the backboard.

Powder Coat Colors:



**White and Black colors are available in Gloss or Flat finishes.

900
SERIES

Porter 900 Series backstops provide the athletic facility designer with the widest variety of product applications while conforming to the latest regulations for championship competition.

This versatile product line comes standard with a fully welded frame up to a 32' attachment height, featuring a 6 5/8" single drop frame with heavy diagonal sway bracing designed and constructed for years of reliable service. A bolt-together frame with internal bracing provides unequalled stability for units up to a 45' height while still allowing installation access through gymnasium doorways.

Backstops are not one size fits all, which is why Porter backstops are custom engineered with the proper supports, bracing, and dimensions to fit your building. You can count on the high performance and safety that defines Porter products.

- POWR-LOK® BRACE HINGES
- ADJUSTABLE MAST HINGES
- OFFSET HINGE WEIGHT LOCK SYSTEM
- HEAVY DIAGONAL SWAY BRACING
- 6 5/8" DIAMETER VERTICAL SUPPORT TUBE
- UP TO 45' ATTACHMENT HEIGHT

 **25** YEAR LIMITED WARRANTY



RAPIDLIFT® CAPABLE

WALL MOUNT BACKSTOPS

**Available for almost any backboard, goal or height adjuster.*

16



219 Up-Fold Series

Backstop folds up with hoisting winch for compact storage of both framework and backboard. Special offset hinge fitting arrangement allows backstop to fold nearly flat against a wall. Backstop extension is available in any dimension from 4' to 18' from the wall.

RECOMMENDED FOR ALL UP-FOLD WALL MOUNT BACKSTOPS:

- 10797120 Safety Strap Kit (For Unit Without Height Adjuster)
- 10797121 Safety Strap Kit (For Unit With Height Adjuster)



220 Side-Fold Series

Backstop folds to side for economical, compact storage. This style is recommended where low ceiling height or obstructions prohibit other folding methods. Backstop is operational from the floor with a telescoping diagonal brace system with a special locking mechanism. Offset hinge fitting allows backstop to fold nearly flat against a wall. Extension is available in any dimension from 4' to 12' from the wall.



312 Stationary Series

Simple, rigid diagonally braced design supports backboard at any extension from .5' to 18' from the wall. Porter's Center-Strut backstops are designed with a direct-mount system which provides a structural mounting support plate directly behind the goal eliminating any strain on the backboard during aggressive play.



Column Mount System

Designed for mounting a fan-shaped backboard and goal to an exposed straight or sloped column (maximum flange width of 15"). Center-Strut direct goal mount design eliminates any strain on the backboard during aggressive play. Unit includes extension frame with special attachment assemblies and mounting hardware only. Specify fan backboard and goal separately. Available with Center-Strut manual height adjustment feature which allows goal height settings from 8'-10'. We recommend column padding for player safety.

- 00310100 Fixed Height System
- 00311100 Height Adjuster System



No. 00904506 Single Drop Electric Height Adjuster

Center-Strut Height Adjusters

Available on the ceiling suspended or wall mounted backstop selection of your choice, along with the option to choose either manual or electric operation. The goal height is easily adjustable to any height from 8' to 10' to accommodate all age levels. Height settings are clearly visible from the floor for accurate adjustments. Electric height adjuster unit incorporates a compact motor to raise and lower the goal height electrically from 8' and 10'.

Optional cordless drill unit allows for power operation of Manual Center-Strut Height Adjuster.

 **1 YEAR LIMITED WARRANTY**

Height Adjuster Options:

- Pow-Touch Systems
- Key Switch
- SportSonic II
- Pow-Stick
- Manual



See page 64 for more information



*Pow-Stick Operator shown

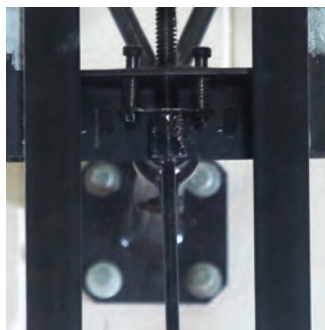
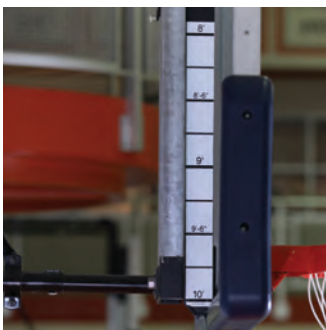

*Manual height adjustment option shown

Advanced Installation Required

Items on these pages may require advanced installation by a trained professional. Incorrect installation may result in product failure and/or warranty void. Installation and fees are customer responsibility. Contact your Porter dealer for additional information.



WINCHES & ACCESSORIES

18



For facilities hosting multiple back-to-back events, the NEW Porter RAPIDLIFT® winch can help turn over the next activity up to 3x as fast. See page 62.

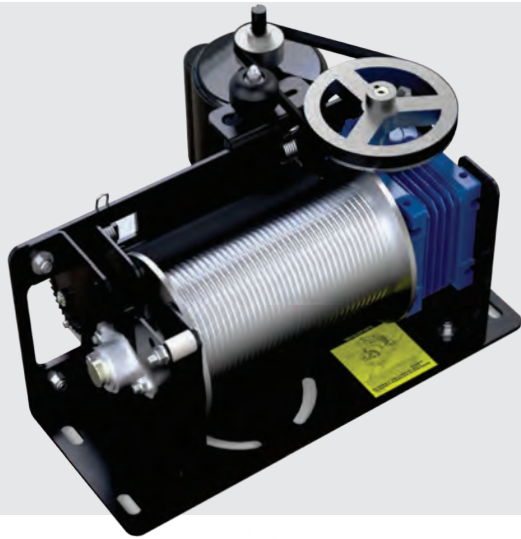

Electric Winch

These equipment winch motors are manufactured to Porter's superior quality and safety requirements, and Porter reputation for durable, high-quality backstop winches in facilities all over the globe. The 712/713 winches come with many improvements and features including a 4" OD extended machined aluminum cable drum allowing 41 ft. of cable capacity on a single layer, an external belt tensioner for easier adjustments and maintenance, and a cable tensioner to keep the cable in place during slack conditions.

The 712/713 basketball backstop winches will operate with Porter's 3-position key switch, Powr-Touch® systems, or SportSonic® II wireless control system.



712
713

¾ HP Winch
1 HP Winch



Electric Winch Operator

Compact, heavy-duty unit to operate Porter's manual winch or any winch with a ¾" square drive shaft. Sufficient power and torque to handle folding backstops up to a 25' attachment height. Double insulated with 50' power cord and two-prong plug. No grounding required. Complete with a durable storage case.

00269000
WINH00048000

Electric Winch Operator
Chuck



Manual Winch

Compact winch with precision-machined, hardened steel worm, forged bronze worm wheel and thrust ball bearing provides smooth, quiet operation and holds backstop in any position. Hand crank sold separately.

00700000
XCRK70000002
REPL10700000
XPAD2100260B

Manual Winch
Hand Crank
Gear Replacement Kit
Wood Pad



Saf-Strap Safety Lock

Any increase in cycle speed or tension, whether sudden or gradual, immediately activates the locking device. The device will lock in any state or cycle, in the event of an over-speed occurrence due to a malfunction of the hoisting apparatus.

797 5 YEAR LIMITED WARRANTY

porter®

POWR-TOUCH® 5



THE ULTIMATE GYM CONTROL SYSTEM

Athletic facility equipment is no longer only about the mechanical, but how new technologies and responsiveness improve customer experience. See page 64.



WIRELESS
CAPABLE



SIMULTANEOUS
UP / DOWN



MULTI-FUNCTION
OPERATION



BACKBOARDS

20



Center-Strut Glass Backboard

This official size 72" x 42" backboard with three point attachment support frame is designed for use only on direct goal mount (Center-Strut) support structures. Brushed aluminum extrusions secure ½" thick fully tempered glass to the fully welded steel frame. Official white border and target area are fired into the glass. Limited lifetime warranty when installed on Porter Center-Strut support systems. Backboard padding is not included but is recommended for player safety. Goal mount centers 5" x 4½".

208 72" x 42" Backboard
208L1 72" x 42" Backboard with LED Lights

20810CXX Center-Strut Package

➕ **INCLUDED:** Backboard, 236154 Powr-Flex® Competition Goal, Pro-Pad Bolt-On Backboard Pad



Pro-Strut Glass Backboard

72" x 42" or 72" x 48" backboard includes a vertical Center-Strut goal support and four corner attachment support frame. This design allows installation on wall-mount units, double drop overhead supported units or old style support system. Brushed aluminum extrusions secure ½" thick fully tempered glass to the unitized steel frame. Official white border and target area are fired into the glass. Limited lifetime warranty. Backboard padding is not included but is recommended for player safety. Goal mount centers 5" x 4½".

204 72" x 42" Backboard
204L1 72" x 42" Backboard with LED Lights
206 72" x 48" Backboard (5" x 5" Mounting Centers)

20410CXX Pro-Strut Package

➕ **INCLUDED:** Backboard, 236154 Powr-Flex Competition Goal, Pro-Pad Backboard Pad



Pro-Strut Conversion Glass Backboard

No additional support structure or hardware is needed to replace a standard fan shaped backboard with this official size 72" x 42" rectangular glass backboard. The two vertical struts with fan shaped backboard mounting centers include all the necessary hardware. Brushed aluminum extrusions secure ½" thick fully tempered glass to the unitized steel frame. Official white border and target area are fired into the glass. Limited lifetime warranty. Goal mount centers 5" x 4½". Backboard padding is not included but is recommended for player safety.

205A 72" x 42" Backboard
2045439 54" x 39" Backboard

2043510CXX Pro-Strut Conversion Package

➕ **INCLUDED:** Conversion Backboard, Powr-Flex Competition, Pro-Pad Backboard





Fiberglass Backboards

The 54" x 39" fan or official size 72" x 42" rectangular backboards are molded from fiberglass. Perimeter flange and structural rib pattern are 1½" deep for rigidity and superior rebound qualities. Official perimeter and target area are screened. Threaded inserts on fan backboard mounting centers allow mounting on any standard support structure. Additional holes are provided for attachment to Center-Strut support system. Goal mount centers 5" x 4½" to 5" x 5". Backboard padding is not included but is recommended for player safety.

- 216 **Rectangle Board**
- 267 **Fan Board**

 **1** YEAR LIMITED WARRANTY



Aluminum Backboards

This 54" x 39" backboard is made from cast aluminum with continuous reinforcing ribs on the backside. Perimeter flange and ribs are 1 ¼" thick for maximum strength. White powder coat finish with optional official perimeter and target area screened in orange. Goal mount centers 5" x 5".

- 234A **White/Orange Board**
- 234 **White Board**

 **LIFETIME** LIMITED WARRANTY



Steel Backboards

72" x 42" or 54" x 39" backboards are designed to withstand rugged play and severe weather conditions. Heavy, 11 gauge steel face has ¼" diameter perforations to minimize wind resistance. Official perimeter and target area are screened on solid steel. Unitized steel support frame has attachment holes on fan backboard mounting centers allowing installation on existing support structures with optional mounting kit. Goal mount centers 5" x 5". Backboard padding is not included but is recommended for player safety.

- 207 **72" x 42" Board**
- 203 **54" x 39" Board**

 **10** YEAR LIMITED WARRANTY

BASKETBALL GOALS

*Net & Mounting Hardware Included

22



TFX

Designed for premier facilities who experience a volume of top-level talent. The Porter TFX Goal absorbs the impact from all directions reducing the shock into a player's hands. Typical arena rims have the ability to only either flex or breakaway. The TFX combines both technologies to provide desired flexibility that is within NBA rules and requirements.



280180

- ✓ 180 Degree Breakaway & Flex Rim
- ✓ Breakaway Release Adjustable From 180-250lbs
- ✓ 5" x 4" to 5" x 4½" Mount Pattern
- ✓ Ring Constructed with 5/8" Alloy Steel
- ✓ Includes Net & Mounting Hardware
- ✓ Tube Tie Net Attachment

✓ 7 YEAR LIMITED WARRANTY



Torq-Flex® Competition

Robust design with 180 degree flex that is perfect for competition play in high school, college, and recreational facilities.

240180

- ✓ 180 Degree Flex Rim
- ✓ 5" x 4" to 5" x 4½" Mount Pattern
- ✓ Tube Tie Net Attachment

✓ 5 YEAR LIMITED WARRANTY



Powr-Flex Competition

An economical competition flex rim.

236154 5" x 4" to 5" x 4½" Pattern
236H00 5" x 5" Pattern (Outdoor)

- ✓ Flex Rim
- ✓ Tube Tie Net Attachment

✓ 5 YEAR LIMITED WARRANTY





Torq-Flex® Elite

Designed for premier facilities that experience a volume of top-level talent. Porter's Torq-Flex Elite Goal reduces the impact into a player's hand from all directions. Unlike standard flex goals, Torq-Flex Elite flexes on all sides of the rim providing equal flexibility regardless of the approach.

260180

- ✓ 180 Degree Flex Rim
- ✓ 5" x 4" to 5" x 4½" Mount Pattern
- ✓ Tube Tie Net Attachment

7 YEAR LIMITED WARRANTY



Ultra Breakaway Competition

A true breakaway rim designed with a positive lock mechanism that releases with a 180 lb. static load.

236054

- ✓ Breakaway Rim
- ✓ 5" x 4" to 5" x 4½" Mount Pattern
- ✓ Tube Tie Net Attachment

5 YEAR LIMITED WARRANTY



Super Goal

Heavy-duty regulation front-mount goal has extra high-tensile strength steel and rugged 5/8" diagonal support bracing.

00225000

5" x 4" to 5" x 4½" Pattern

00235000

5" x 5" Pattern (Outdoor)

1 YEAR LIMITED WARRANTY

Heavy-Duty Playground

This indestructible goal is the most rugged outdoor goal available with solid double 5/8" diameter rim design.

00251H00
00161000

5" x 5" Pattern (Outdoor)
Zinc-plated Chain Net

UNCONDITIONAL LIFETIME WARRANTY



Chain Net Sold Separately

Double Rim Playground

Heavy-duty, double rim construction makes this front-mount goal withstand rugged playground use.

00202H00

5" x 5" Pattern (Outdoor)

1 YEAR LIMITED WARRANTY



Championship® Goal

Intended for residential use only, not for use on school or public playgrounds. Fits Championship/U-Can-Slam residential systems.

09143000

3" x 4" Pattern

1 YEAR LIMITED WARRANTY



ACCESSORIES

24



LED Perimeter Lights

LED lights comply with the latest NBA, NCAA, and FIBA recommendations and meet NFHS end of period light requirements. Lights are neatly contained within a custom aluminum extrusion and mount directly inside the perimeter backboard markings providing a clean, uncluttered appearance. Order one set per backboard.



Center-Strut Rectangular Glass Backboard

- 820801 LED light set with synchronizer
- 820802 LED light set with Daktronics cord
- 820803 LED light set with Nevco cord

Pro-Strut Rectangular Glass Backboard

- 820401 LED light set with synchronizer
- 820402 LED light set with Daktronics cord
- 820403 LED light set with Nevco cord



Pro-Pad Bolt-On Backboard Padding

Featuring self-tapping screws, the Pro-Pad is the easiest backboard pad in the industry to install. The improved 2-hole design is extremely durable and is manufactured with a tough molded urethane skin that is painted in the mold with a color matched urethane paint to provide the exterior with uniform colored appearance. Meets all competition requirements of the NBA, NCAA, NFHS and International requirements of FIBA. **Pads one backboard.**

 **10** YEAR LIMITED WARRANTY

- | | | | |
|----------|-------------|----------|-------------|
| 00326000 | Gray | 00326400 | Maroon |
| 00326100 | Red | 00326500 | Orange |
| 00326200 | Royal Blue | 00326600 | Black |
| 00326210 | Navy Blue | 00326700 | Purple |
| 00326300 | Kelly Green | 00326800 | Yellow Gold |
| 00326310 | Dark Green | 00326220 | Light Blue |



Adhesive Backboard Pads

Pads molded from self-skinning polyurethane foam. Fast-setting adhesive installation. Available in gray only. **Pads one backboard.**

- 227 For 2" Thick Backboards
- 229 For 1 9/16" Thick Backboards



Net Tube-Tie Cord

Replacement nylon cord for our tube-tie basketball goal system. Includes hardware.

ROND00123100



Nylon Net

09608012
Anti-Whip Net 12 Pack

09608000
Anti-Whip Net



Tamper Proof Hardware for Goals

Wards off the most determined theft or vandalism attempts! Set of four round head bolts with special high security nuts using a torque limiting breakaway head section combined with a free turning protective sleeve. For use on any Porter standard front-mount goal. No special tools are required for installation.

01218000



Chain Net

Zinc-plated. Attaches to any style rim with heavy duty S-hooks. Fits 00251H00 heavy duty playground goal.

00161000

SHOW THEM WHO OWNS THE COURT.

Give your school or facility a true home team advantage with custom printed graphics. See Page 74.



GOOSENECK SYSTEMS

USE THE MATRIX TO CHOOSE YOUR EXTENSION DISTANCE, POLE DIAMETER, BACKBOARD, AND GOAL

10 YEAR LIMITED WARRANTY

26

4' Extension 4½" Diameter Pole		00235000 Super Goal	00202H00 Double Rim	00251H00 Heavy-Duty	236H00 Powr-Flex Competition
267 Fan Fiberglass		17412	17413	17414	17415
234 Fan Aluminum White		17422	17423	17424	17425
234A Fan Aluminum		17432	17433	17434	17435



Discover Our
Most Popular
Combinations

5' Extension 4½" Diameter Pole					
267 Fan Fiberglass		17512	17513	17514	17515
234 Fan Aluminum White		17522	17523	17524	17525
234A Fan Aluminum		17532	17533	17534	17535
216 72" x 42" Fiberglass		17582	17583	17584	17585

Super Duty System

Provides the utmost in safety and strength during even the toughest play. California and Florida specifications require extended pole length for a 2' deeper footing.

00251H00
Heavy-Duty

236H00
Powr-Flex
Competition

6' Extension 5 ⁹ / ₁₆ " Diameter Pole							
267 Fan Fiberglass		17612	17613	17614	17615		
234 Fan Aluminum White		17622	17623	17624	17625		
234A Fan Aluminum		17632	17633	17634	17635	176FLSD340	176FLSD350
207 72" x 42" Steel		17652	17653	17654	17655	176FLSD540	176FLSD550
205A 72" x 42" Glass		17662	17663	17664	17665	176FLSD640	176FLSD650
216 72" x 42" Fiberglass		17682	17683	17684	17685		



Custom Powder Coat

When Ordering: Add "C" followed by the 2-digit color number to the end of the item number.
 Ex: 17634C12 (shown above)

**Not available for Super Duty Systems*

01 LIGHT BLUE	02 ROYAL BLUE	03 RED	04 WHITE	05 ORANGE	06 YELLOW GOLD	07 SILVER	08 OLD GOLD	09 GRAY
10 MAROON	11 PURPLE	12 BLACK	13 NAVY BLUE	14 KELLY GREEN	15 DARK GREEN	22 ARCH BLACK	23 ARCH GRAY	

VERTICAL POST SYSTEMS

USE THE MATRIX TO CHOOSE YOUR EXTENSION DISTANCE, POLE DIAMETER, BACKBOARD, AND GOAL

10 YEAR LIMITED WARRANTY

Super Duty System

Provides the utmost in safety and strength during even the toughest play. California and Florida specifications require extended pole length for a 2' deeper footing.

4' Extension 4½" Diameter Pole		00235000 Super Goal	00202H00 Double Rim	00251H00 Heavy-Duty	236H00 Powr-Flex Competition	00251H00 Heavy-Duty	236H00 Power-Flex Competition
267 Fan Fiberglass		16412	16413	16414	16415		
234 Fan Aluminum White		16422	16423	16424	16425		
234A Fan Aluminum		16432	16433	16434	16435	164FLSD340	164FLSD350
216 72" x 42" Fiberglass		16482	16483	16484	16485		

6' Extension 5 ⁹ / ₁₆ " Diameter Pole							
267 Fan Fiberglass		16612	16613	16614	16615		
234 Fan Aluminum White		16622	16623	16624	16625		
234A Fan Aluminum		16632	16633	16634	16635		
207 72" x 42" Steel		16652	16653	16654	16655	166FLSD540	166FLSD550
205A 72" x 42" Glass		16662	16663	16664	16665	166FLSD640	166FLSD650
216 72" x 42" Fiberglass		16682	16683	16684	16685		



Vertical Post Systems Are Also Available in Back-To-Back Configurations. Call For Pricing & Details.



Custom Powder Coat

When Ordering: Add "C" followed by the 2-digit color number to the end of the item number. Ex: **16654C01**

**Not available for Super Duty Systems*

01 LIGHT BLUE	02 ROYAL BLUE	03 RED	04 WHITE	05 ORANGE	06 YELLOW GOLD	07 SILVER	08 OLD GOLD	09 GRAY
10 MAROON	11 PURPLE	12 BLACK	13 NAVY BLUE	14 KELLY GREEN	15 DARK GREEN	22 ARCH BLACK	23 ARCH GRAY	

ADJUSTABLE SYSTEMS

30



Big Shot® Pro System

The Big Shot Pro System features a rugged support system with anchor bolt mounting. Glass backboard has a weather resistant, powder coated, unitized steel rear support structure and is fitted in an aluminum frame to provide superior ball rebound. Official white perimeter and target area markings are silk screened on the backside to prevent wear.

Includes the Powr-Flex goal, a flex rim that protects players and equipment during slam-dunk with a concealed shock absorber.

Includes backboard system, goal, nylon net, pole pad, backboard pad, & mounting hardware. 6" pole with 4' offset and 72" x 42" backboard.

9572 Pro Package

Includes System, Pole and Backboard Pad.



Big Shot® Collegiate System

Includes the Powr-Flex goal

Includes backboard system, goal, nylon net, & mounting hardware. 5" pole with 2'6" offset and 60" x 36" backboard.

9571 Collegiate Package

Includes System, Pole and Backboard Pad.



Championship System

Rigid feel and authentic rebound characteristics make this unit the best value in home basketball systems. 4" square pole has extension arm and sway braces to enhance unit stability. The direct goal mount provides superior strength and rigidity to the 48" x 36" acrylic backboard.

Includes backboard system, goal, nylon net, & mounting hardware.

092320FG	System
09432912	Pole Pad (4")
00324648	Backboard Pad

OUTDOOR SYSTEMS



Heavy-Duty System

Heavy-duty support structure provides tremendous strength and is designed to withstand the most rugged playing conditions. Backstop provides a 5' extension into the playing court for maximum safety. Available as a single post or a back-to-back system when a multiple court layout is desired. Unconditional Lifetime Warranty is provided on the most rugged outdoor goal available. Great system for regulation outdoor competitions.

Official size 72" x 42" perforated backboard is 11 gauge steel with a massive rear support framework. Backboard is screened with official perimeter and target area markings. Backboard, goal and pole have an extremely durable powder coated finish.

00195580
00195582
09532912
00324672

Standard System
Back-to-Back System
Pole Pad
Backboard Pad

 **UNCONDITIONAL** LIFETIME WARRANTY



Ultimate Outdoor System

Turn any outdoor court into an official arena! Includes 6' vertical pole, 72" x 42" Center-Strut glass backboard, 00256500 Torq-Flex Goal, and anti-whip net.

16675CXX

 **10** YEAR LIMITED WARRANTY

Ultimate Outdoor Powder Coat Colors:



When Ordering: Use the 2-digit color number to replace XX in the item number.

Shown in Navy Blue Powder Coat.



Rock Solid System

Built to withstand the elements and the occasional natural disaster! This custom model meets Florida's hurricane wind load standards and is as heavy duty as they come featuring an extra large schedule 80 (4½") gooseneck pole.

Includes schedule 80 gooseneck pole, 234A aluminum fan backboard, 00251H00 heavy-duty playground goal, and chain net.

175340FL

 **UNCONDITIONAL** LIFETIME WARRANTY



1900 POWR-NET

MOTORIZED SYSTEM

32

COMPETITION

91920100 Single Court w/ Judge's Stand

SYSTEMS ONLY

91910100 Single Court
 91910200 Dual Court
 91910300 Triple Court

Optional
 Replacement Net
 Frame Pad Graphic

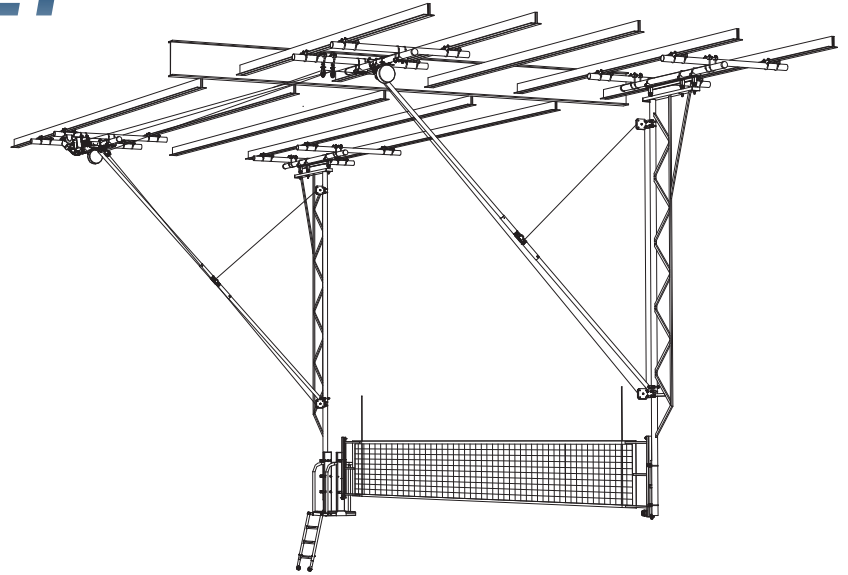

Powder Coat Colors:



***White and Black colors are available in Gloss or Flat finishes.*

Powr-Net Features:



Unitized bridged vertical support frame provides excellent system rigidity during play.



No part of the Porter system touches the ground when in use.

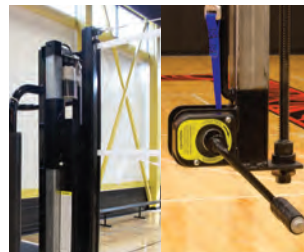

Electric or manual net height adjustment options are available.



Optional judge's stand provides an unobstructed view of the entire court.

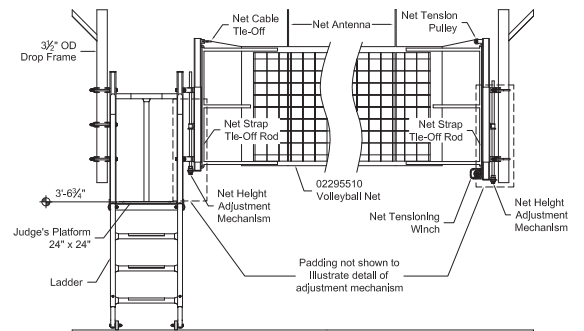
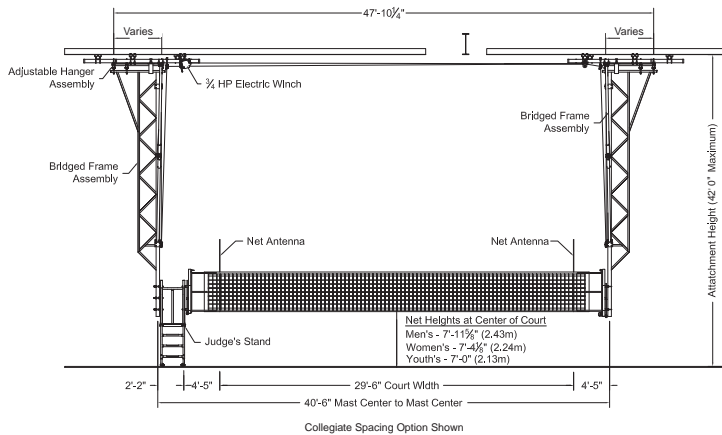

Vinyl Colors:



VOLLEYBALL



**1900
SERIES**

The 1900 SERIES POWR-NET Overhead Volleyball System can't be beat when instant and frequent volleyball court set-up is required. The entire volleyball system, including net, judge's stand, and padding quickly and conveniently fold to the overhead storage position electrically.

The narrow profile of the unitized steel support frame contains internal truss-type webbing for excellent stability. Each drop frame is laterally braced by a folding brace system with dual formed steel hinges incorporating torsion springs to lock the unit in playing position for maximum stability. Each drop frame support may be furnished with a Saf-Strap safety lock to comply with operational safety requirements. Single or multiple court systems may be furnished utilizing a single electric winch with up and down limit switch operation. Protective padding that meets all competition requirements is provided on the net height adjustment mechanism as well as the optional judge's platform.

- ONE-STEP SETUP
- MANUAL AND ELECTRIC NET HEIGHT ADJUSTMENTS
- MEETS NFHS AND NCAA REGULATIONS
- CUSTOM PADDING GRAPHICS

 **1** YEAR LIMITED WARRANTY



RAPIDLIFT® CAPABLE



CUSTOM GRAPHICS AVAILABLE

POWR-CARBON™ II STANDARD

meet requirements for:
FIVB NCAA NFHS

34



Competition Package PLUS

20930XX 3" Diameter

PACKAGE INCLUDES:

2093 Powr-Carbon II Standards (pr), 8390XX Official Upright Protective Pads (pr), 2295 Competition Net, 2297 Powr-Select Net Antenna (pr), **NETCHAIN** Fair Height Net Chain, 669100 Free Standing Judge's Stand, 6693XX Judge's Stand Padding

Competition Package

20931XX 3" Diameter

PACKAGE INCLUDES:

2093 Powr-Carbon II Standards (pr), 8390XX Official Upright Protective Pads (pr), 2295 Competition Net, 2297 Powr-Select Net Antenna (pr), **NETCHAIN** Fair Height Net Chain



CUSTOMIZE IT!
SEE PAGE 45

Vinyl Colors: (xx)

01 LIGHT BLUE	02 ROYAL BLUE	03 RED	04 WHITE	05 ORANGE	06 YELLOW GOLD	08 TAN
09 GRAY	10 MAROON	11 PURPLE	12 BLACK	13 NAVY BLUE	14 KELLY GREEN	15 DARK GREEN

Crafted in the USA, the Powr-Carbon standard provides the lightest weight of any Porter standard at 19 lb! Not only is this standard exceptionally lightweight, but is also features incredibly strong carbon fiber material.

10 YEAR LIMITED WARRANTY

- ✓ Designed for Premier Facilities
- ✓ 3" OD Carbon Sleeve
- ✓ High Gloss Protective Coating
- ✓ Adjustable Bottom Foot
- ✓ Lightweight Composite Pulley Wheel
- ✓ Worm Drive Net Winch

End Standards

2093 3" Diameter
20939XX 3" Diameter with Official Pads

meet requirements for:
FIVB NCAA NFHS

POWR-STEEL™ STANDARD



Competition Package PLUS

17910XX 3" Diameter

PACKAGE INCLUDES:

1791 Powr-Steel Standards (pr), 8390XX Official Upright Protective Pads (pr), 2295 Competition Net, 2297 Powr-Select Net Antenna (pr), NETCHAIN Fair Height Net Chain, 669100 Free Standing Judge's Stand, 6693XX Judge's Stand Padding

Competition Package

17911XX 3" Diameter

PACKAGE INCLUDES:

1791 Powr-Steel Standards (pr), 8390XX Official Upright Protective Pads (pr), 2295 Competition Net, 2297 Powr-Select Net Antenna (pr), NETCHAIN Fair Height Net Chain



CUSTOM GRAPHICS
AVAILABLE

CUSTOMIZE IT!
SEE PAGE 45

Vinyl Colors: (xx)

01 LIGHT BLUE	02 ROYAL BLUE	03 RED	04 WHITE	05 ORANGE	06 YELLOW GOLD	08 TAN
09 GRAY	10 MAROON	11 PURPLE	12 BLACK	13 NAVY BLUE	14 KELLY GREEN	15 DARK GREEN

The 1791 Porter Powr-Steel standards are a combination of endless function, style, and stability. The 3" OD steel uprights are sleek, strong, and weigh less than 50 lb each. The Powr-Steel System is designed for long lasting play at all levels.

- ✔ Designed For College Athletes
- ✔ Steel Inner Upright
- ✔ Cast Iron Pulley Wheel
- ✔ Worm Drive Nut Winch
- ✔ 7 Laser Cut Height Stops



LIFETIME LIMITED WARRANTY

End Standards

1791 3" Diameter
17919XX 3" Diameter with Official Pads

Telescoping Center Standards

1792 3" Diameter
17929XX 3" Diameter with Official Pad

REPLACEMENT PARTS

WINH00113 Powr-Select Winch
FEET1791 Rubber Foot
HAND1791 Pull Pin

SOLD SEPARATELY

Page 18 Volleyball Net
Page 16 Upright Pads
Page 20 Judge's Stand
Page 19 Net Antennas
Page 19 Boundary Markers
Page 22 Sleeve Adapters
Page 22 Floor Sleeves
Page 17 Graphic Pads



POWR-LINE™ STANDARD

meet requirements for:
FIVB NCAA NFHS

36



Considering a Powr-Line Package? Check out our Powr-Court System on page 12.



Competition Package PLUS

- 19830XX 3" Diameter
- 19810XX 3½" Diameter

PACKAGE INCLUDES:

1993 or 1991 Powr-Line Standards (pr), 8390XX Official Upright Protective Pads (pr), 2295 Competition Net, 2297 Powr-Select Net Antenna (pr), **NETCHAIN** Fair Height Net Chain, 669100 Free Standing Judge's Stand, 6693XX Judge's Stand Padding

Competition Package

- 19831XX 3" Diameter
- 19811XX 3½" Diameter

PACKAGE INCLUDES:

1993 or 1991 Powr-Line Standards (pr), 8390XX Official Upright Protective Pads (pr), 2295 Competition Net, 2297 Powr-Select Net Antenna (pr), **NETCHAIN** Fair Height Net Chain



CUSTOMIZE IT!
SEE PAGE 45

Vinyl Colors: (xx)

01 LIGHT BLUE	02 ROYAL BLUE	03 RED	04 WHITE	05 ORANGE	06 YELLOW GOLD	08 TAN
09 GRAY	10 MAROON	11 PURPLE	12 BLACK	13 NAVY BLUE	14 KELLY GREEN	15 DARK GREEN

Researched, engineered and manufactured to meet the demands of championship play with maximum safety, quick set-up and easy storage. The Powr-Line high strength, lightweight aluminum volleyball system is ready to meet your most exacting demands. Net heights are Olympic competition through elementary height settings as specified by the FIVB, NFHS and the USAV. Volleyball net and floor sleeves not included with standards.

- ✓ Telescoping Upright Glides Smoothly And Safely Up And Down.
- ✓ Simple Net Attachment.
- ✓ Reinforcing Rib Pattern Offering Superior Strength.
- ✓ Easy to Transport
- ✓ Most Popular High School Standard
- ✓ Unlimited Custom & All Competitive Height Settings

10 YEAR LIMITED WARRANTY

End Standards

- 1993 3" Diameter
- 19939XX 3" with Official Pads
- 1991 3½" Diameter
- 19919XX 3½" with Official Pads

Telescoping Center Standards

- 1994 3" Diameter
- 19949XX 3" with Official Pad
- 1992 3½" Diameter
- 19929XX 3½" with Official Pad

meet requirements for:
NFHS

POWR-RIB™ II STANDARD

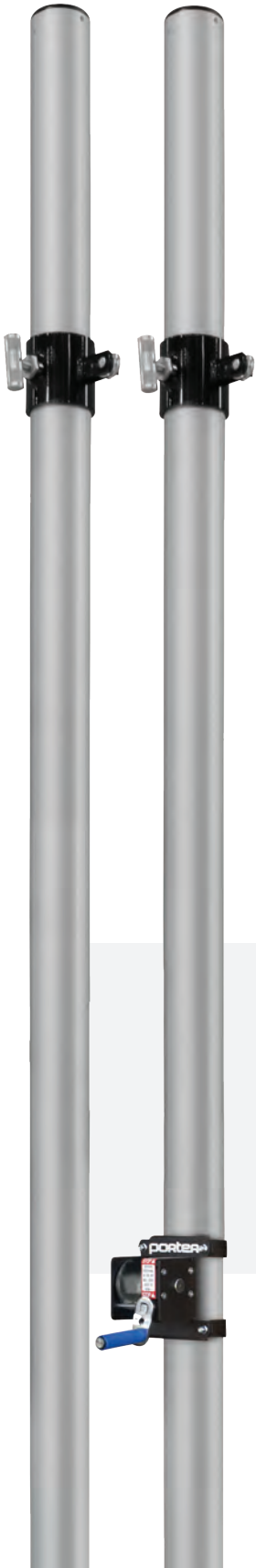

Competition Package PLUS

- 19630XX 3" Diameter
- 19610XX 3½" Diameter

PACKAGE INCLUDES:

1973 or 1991 Powr-Rib II Standards (pr), 8390XX Official Upright Protective Pads (pr), 2295 Competition Net, 2297 Powr-Select Net Antenna (pr), **NETCHAIN** Fair Height Net Chain, 669100 Free Standing Judge's Stand, 6693XX Judge's Stand Padding

Competition Package

- 19631XX 3" Diameter
- 19611XX 3½" Diameter

PACKAGE INCLUDES:

1973 or 1971 Powr-Rib II Standards (pr), 8390XX Official Upright Protective Pads (pr), 2295 Competition Net, 00546000 Boundary Marker with Antennas (pr), **NETCHAIN** Fair Height Net Chain



CUSTOMIZE IT!
SEE PAGE 45

Vinyl Colors: (xx)

01 LIGHT BLUE	02 ROYAL BLUE	03 RED	04 WHITE	05 ORANGE	06 YELLOW GOLD	08 TAN
09 GRAY	10 MAROON	11 PURPLE	12 BLACK	13 NAVY BLUE	14 KELLY GREEN	15 DARK GREEN

The Powr-Rib II standard is constructed of high strength, lightweight aluminum. Two reinforcing ribs are centered throughout the entire length of the post for added system strength. Top and bottom of posts are fitted with custom molded caps to protect finished floors. Built-in channel runs the length of the post and allows for the collar to slide up and down the post easily, with custom height settings for multi-sport applications. Collar locks in place in seconds with pressure lock t-handle. Available optional center post for unlimited multi-court layouts. Functional multi-use system provides height adjustment settings and visual labels for men's, women's and junior USAV competition height settings.

- ✓ Multi-Sport Functionality
- ✓ Junior High, High School, Intramurals

10 YEAR LIMITED WARRANTY

End Standards

- 1973 3" Diameter
- 19739XX 3" with Official Pads
- 1971 3½" Diameter
- 19719XX 3½" with Official Pads

Split Collar Center Standards

- 1974 3" Diameter
- 19749XX 3" with Official Pad
- 1972 3½" Diameter
- 19729XX 3½" with Official Pad

POWR-SAND™ STANDARD

38

STANDARD PACKAGE

30911XX

Package Includes:

- 3091 Powr-Sand Standards (pr)
- 83900XX Official Upright Protective Pads (pr)
- 2256 Outdoor Competition Net
- 2297 Powr-Select Net Antennas (pr)
- NETCHAIN Fair Height Net Chain

INTERNATIONAL PACKAGE

30910XX

Package Includes:

- 3091 Powr-Sand Standards (pr)
- 83900XX Official Upright Protective Pads (pr)
- 2256 Outdoor Competition Net
- 2297 Powr-Select Net Antennas (pr)
- NETCHAIN Fair Height Net Chain
- 3070 Powr-Sand Judge's Stand
- 6693XX Powr-Sand Judge's Stand Padding
- 451 Sand Rake

POWR-SAND STANDARDS/PADS

- 3091 Powr-Sand Standards (pr)
- 3060XX Powr-Sand Pads (pr)

GROUND SLEEVES

- 3080 Sand Ground Sleeves (each)

JUDGE'S STAND/STAND PADS

- 3070 Judge's Stand
- 6693XX Judge's Stand Pads

- Page 59 Graphic Pads



Professional Outdoor Court Line Kit

Durable 2" nylon volleyball line system for quickly and efficiently marking outdoor volleyball courts. Adjustable to USAV regulation or short court. Includes ground stakes and plastic reel. Available in blue or black.

- TA379 Black
- TA380 Blue



Powr-Sand, Porter's aluminum telescoping standard, was created for top level competition with thoughtful features that allow users to have equipment remain outdoors year round or remove when not in use. A pin stop telescoping standard with powdered coated handle is easily adjustable across all competitive volleyball heights. Pair the Powr-Sand standards with our high visibility Powr-Sand outdoor volleyball net, protective padding, boundary marker antennas, court marking kit and optional sand judge's stand for all the equipment needed for training and competition.

- ✓ Constructed Of High Strength, Lightweight Aluminum
- ✓ Two Reinforcing Ribs Are Centered Throughout The Entire Length Of The Post For Added System Strength
- ✓ Sealed Lower Upright Prevents Water/Sand Build-Up
- ✓ Features Heavy Duty Winch With Cover
- ✓ Pin-Lock Net Height Adjustment
- ✓ Functional Multi-Use System Provides Height Adjustment Settings For Men's, Women's And Junior USAV Competitions

10 YEAR LIMITED WARRANTY



POWR-COURT™ PRO SYSTEM

POWR-COURT PRO SYSTEM

- 1945CXXYY Standard System
- 1945CXXYYSP System With Custom Graphics

REPLACEMENT PARTS

- WINH00113 Powr-Select Winch



Introducing Powr-Court™ Pro, a truly portable volleyball system. Powr-Court Pro quickly and easily transforms almost any location into a volleyball court. The steel, telescoping standards have infinite height adjustment settings and are welded to ballasted bases. With a ballast of 500lb per base this system is secure, does not require floor anchors, and will not “creep”. One base unit is equipped with a built-in judge’s stand including anti-fatigue mat. The second base unit houses the universal winch. Bases are padded with thick shock absorbing foam and covered in a heavy 19oz vinyl.

The system comes complete with 2 padded bases, a competition net, net antennas, and net height chain. Customize with your choice of color for the vinyl pads and base frame. Custom graphics available on base pads for additional cost. The Powr-Court Pro weldments are backed by a lifetime limited warranty; 1 year warranty on all other parts.

- ✓ Standards are marked with four net heights: 10’s, 12’s, Women’s and Men’s
- ✓ Entire system complies with USAV, NCAA, and NFHS requirements for competition volleyball.

 **10 YEAR LIMITED WARRANTY**

Vinyl Colors: (xx)

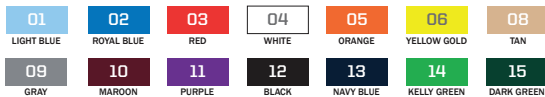

POWR-COURT™ SYSTEM

A completely portable system utilizing Powr-Line uprights that is designed for competition and recreational play. The 750lb ballast base and no-creep foot pad keep the base in position during use. The system’s crank lifts the base and allows it to maneuver. Upgrade your system by adding an optional fitted judge’s stand and customized upright padding. Includes net, antenna, and padding.

- 1935XX Standard System
- 1935XXSP System With Custom Graphics

SOLD SEPARATELY See Page 20 For Details

- 00999000 Judge’s Stand
- 9931XX Judge’s Stand Padding



*Optional Judge’s Stand Shown



*Custom Graphics Shown

RECREATIONAL STANDARDS

40



Powr-Trak Standards

The Powr-Trak's unique design makes this system the perfect choice for physical education facilities that need a lightweight, easy-to-use system. Versatile standards for multi-sport use including tennis and badminton.

- ✓ Height Adjustable Pulley And Tensioning Winch Equipped With A Nylon Tension Strap.
- ✓ Lightweight, High Strength Aluminum
- ✓ Internal Reinforced Rib Minimizes Deflection
- ✓ Attractive Anodized Silver Finish With Fitted End Caps To Protect Finished Floors

END STANDARDS

1951	3½" Diameter
19519XX	3½" Diameter with Pads
1955	Portable
19559XX	Portable with Pads

CENTER STANDARDS

1952	3½" Diameter
19529XX	3½" Diameter with Pads
1956	Portable
19569XX	Portable with Pads



Ultimate Outdoor Volleyball Standards

Height adjustable posts are constructed of high-tensile strength, lightweight aluminum for durability and easy set-up. Uprights are 4" square with a built-in channel running the length of the post which allows the collar to easily slide up and down the post, providing infinite height settings. Finished in a weather resistant clear anodized finish. Net not included.

591

SOLD SEPARATELY

2256	27'10" x 3'3" Net
00444000	Ground Sleeve for Dirt
5930XX	Protective Pads

SAND UNIT

592	Sand Conversion Kit
00444040	Ground Sleeve for Sand



Economy Standards

Sturdy, utility construction makes the Economy Standards great for practice courts, cross court setups, and elementary school use. Nets sold separately.

- ✓ Powder Coated Steel Standards
- ✓ Winch Includes A Nylon Tension Strap For Installing And Fine Tuning Your Volleyball Net
- ✓ Net Heights Are Quickly And Easily Adjustable For Competition Settings Using A Sliding Collar And Spring Loaded Pin

End Standards

- | | |
|--------|---------------------------------|
| 851 | 3½" Diameter |
| 8519XX | 3½" Diameter with Official Pads |

*GREAT FOR P.E. CLASSES
& RECREATION FACILITIES*



NETS & ACCESSORIES

42



Universal Competition Volleyball Nets

Superior quality construction throughout makes this heavy-duty net an ideal companion to any of Porter's competition volleyball systems. Heavy 4" square netting is provided in black, #24 nylon cord which exceeds specification requirements for all levels of competition. Kevlar Fibercord top cable is available in two lengths. Six, one-inch wide polypropylene tension straps working in conjunction with composite fiberglass dowels hidden in the end pockets provide unmatched appearance and the ultimate in net tension and performance. All nets measure 32' x 39".

2295
2295XL

Powr-Sand Outdoor Volleyball Net

The Powr-Sand Outdoor Volleyball net features a tough, durable Kevlar top cable, highly-visible yellow vinyl, and three nylon tensioning straps for a tight fit. Measures 27'10" x 3'3".

2256

Powr-Select™ Winch

For volleyball facilities who are looking for a dependable net tensioning winch. The Porter Powr-Select Winch is engineered to provide a consistent and smooth operation for the long-term. Compatible with all systems from 3" to 3.5".

WINH00113

Replacement Winch Handle Available Online





00546000

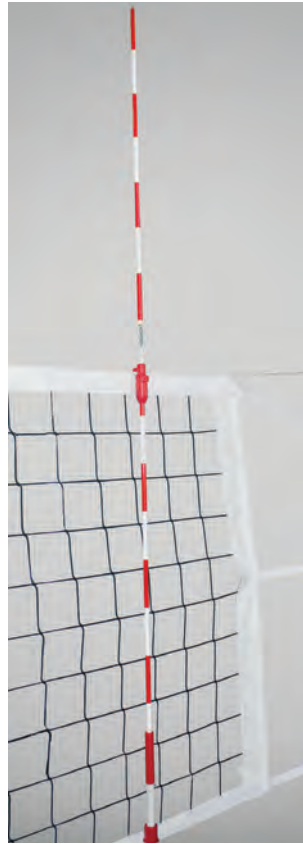

2297

Net Antennas & Boundary Markers

International quality net antenna with molded, positive locking type clamps for securing to the top and bottom net hems. Single unit prevents lost parts. Meets all FIVB, USAV, NCAA, and NFHS competition requirements.

Boundary markers are 2" wide white polyester reinforced vinyl straps with hook & loop attachment strips to secure to the net.

- 2297 Powr-Select Net Antenna
- 00546000 Boundary Marker w/ Antenna



Sidewinder Net Storage System

Easily wind your volleyball nets on a free standing, transportable rack to keep your nets clean and tangle-free. The storage racks spin easily to neatly grasp and store the headband of the nets as unit glides across the floor on frictionless swivel type casters. Heavy-duty all steel construction has a durable powder-coated finish.

- 00821100 Single (stores 1 net)
- 00823100 Triple (stores 3 nets)



Fair Height Net Chain

Measures the distance from the top of the net tape to the playing surface for a consistent and fair net height. The top hook fastens to the net, and orange markers along the chain represent four competition net height standards: 6'6", 7-0", 7'4¹/₈", 7'11⁵/₈"

NETCHAIN

UPRIGHT PADDING



CUSTOM GRAPHICS AVAILABLE



CUSTOMIZE IT!



Official Upright Pads

Tailored pads are miter cut and hinged to fold neatly around uprights and tensioning reels to provide a slim profile. Durable polyester reinforced 15oz vinyl covers, 1½" thick polyethylene filler with hook and loop attachments.

- 8390XX End Pads
- 8391XX Center Pad

When Ordering: Use the two-digit vinyl color number to replace XX in the item number.

IT'S YOUR COURT

VOLLEYBALL

01 LIGHT BLUE

02 ROYAL BLUE

03 RED

04 WHITE

05 ORANGE

06 YELLOW

08 TAN

09 GRAY

10 MAROON

11 PURPLE

12 BLACK

13 NAVY BLUE

14 KELLY GREEN

15 DARK GREEN

CUSTOM GRAPHICS

Give your court a true home team advantage with custom printed graphic upright pads! Simply provide your logo vector artwork and our design team works with you to create a stunning display.



LOOK FOR THIS ICON

Custom Graphics Add SP to end of item #



Volleyball Net Sleeve

Show your team spirit with this fully customizable volleyball top tape net sleeve. Hook and loop closure attaches to any manufacturers' net quickly without affecting net playability. Constructed of heavy 15oz vinyl-coated polyester fabric material. 100 P.S.I. tear strength.

NETSLVE0032

JUDGE'S STANDS



Free Standing Judge's Stand

Free standing, portable judge's stand is ideal for use as a training aid on any sleeved volleyball system. Unit folds down enabling entire stand to be placed in a flat, compact unit for storage. Non-marking casters provided to easily transport to and from storage. Available with optional protective padding to meet all requirements for competition.

- 669100 Free Standing Judge's Stand
- 6693XX Free Standing Stand Pads

Vinyl Colors: (xx)

01 LIGHT BLUE	02 ROYAL BLUE	03 RED	04 WHITE	05 ORANGE
06 YELLOW GOLD	08 TAN	09 GRAY	10 MAROON	11 PURPLE
12 BLACK	13 NAVY BLUE	14 KELLY GREEN	15 DARK GREEN	



Fitted Judge's Stand

Designed specifically for use with Porter's competition volleyball systems. Wide stance, vertical ladder type support frame provides excellent stability for all levels of competition. Nominal two foot square platform with formed side rails provides a secure platform with an excellent viewing position. Non-marking rubber feet and 3" diameter wheels allow for easy tipping and rolling to and from storage areas. Powder-coated finish provides the utmost in durability. This stand is designed for maximum spectator visibility when used with optional protective padding kit to meet all requirements for competition.

- 00889100 For Powr-Rib II, Powr-Trak, and Economy
- 00999000 For Powr-Line
- 779100 For Powr-Steel, Powr-Carbon II
- 9931XX Fitted Stand Pads
- 7731XX Fitted Stand Pads; Powr-Steel, Powr-Carbon II

Vinyl Colors: (xx)

01 LIGHT BLUE	02 ROYAL BLUE	03 RED	04 WHITE	05 ORANGE
06 YELLOW GOLD	08 TAN	09 GRAY	10 MAROON	11 PURPLE
12 BLACK	13 NAVY BLUE	14 KELLY GREEN	15 DARK GREEN	



825

Wall Storage Rack

Storage rack provides a convenient method for storing two volleyball standards in a compact space. Each upright is held in place with a hook-and-loop closure. Wall installation hardware included.

825



825 With 82501 Add-On

Locking Wall Storage Rack

Add this locking front gate mechanism to your existing 825 wall storage rack or purchase both to create a secure storage place for two standards. Includes lock, easy to install.

82501



Powr-Steel Judge's Stand Wall Bracket

Judge's stand wall storage rack compatible with the 779100 fitted judge's stand. This storage solution safely secures the judge's stand to the wall while taking up the smallest floor footprint possible.

99910



Fitted Judge's Stand Wall Bracket

Judge's stand wall storage rack compatible with 00889100 & 00999000 fitted judge's stands. This storage solution safely secures the judge's stand to the wall while taking up the smallest floor footprint possible.

89910



Standard Transporter

Steel boot with non-marking wheels slides easily onto the end of any standard which is then easily rolled to the storage location.

9564

Powr Volleyball Transport System

Convenient, specially designed heavy-duty transport system is equipped to store three full competition volleyball courts complete with standards, protective pads, nets, judge's stand and balls. Rolls easily from gym to storage room on 3½" diameter swivel casters.

00956100

SLEEVES & PLATES

48



5" Chrome Finish

5" Sleeves and Cover Plates

Choose both finish style and sleeve diameter. Includes both a sleeve and cover plate. Sold individually, not in pairs.

Sleeve with Cover Plate: Chrome Finish

- 00770100 2³/₈"
- 00790100 3"
- 00870100 3¹/₂"

Sleeve with Cover Plate: Brass Finish

- 00770200 2³/₈"
- 00790200 3"
- 00870200 3¹/₂"

Replacement 5" Cover Plates

- COVR00002000 Chrome
- COVR00034000 Brass

Replacement 5" Molded Collar

- COVR0003200T

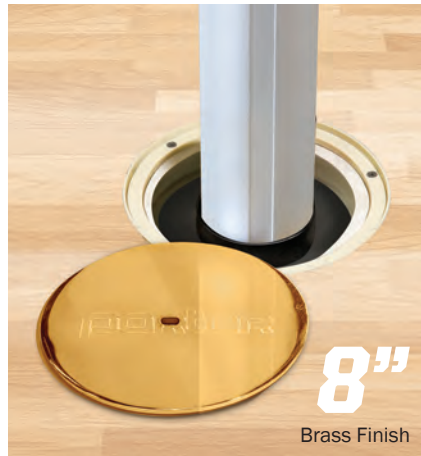

8" Brass Finish

8" Sleeves and Cover Plates

Choose both finish style and sleeve diameter. Includes both a sleeve and cover plate. Sold individually, not in pairs.

Sleeve with Cover Plate: Chrome Finish

- 00772100 2³/₈"
- 00792100 3"
- 00872100 3¹/₂"

Sleeve with Cover Plate: Brass Finish

- 00772200 2³/₈"
- 00792200 3"
- 00872200 3¹/₂"

Replacement 8" Cover Plates

- COVR00027000 Chrome
- COVR00035000 Brass

Replacement 8" Molded Collar

- COVR0003300T



Sleeve Adapters

To convert existing sleeves for use with smaller diameter standards. Sold individually, not in pairs.

- 00827000 Converts 3¹/₂" to 2³/₈"
- 00827300 Converts 3¹/₂" to 3"
- 00826000 Converts 4" to 3¹/₂"

T-Handle Sleeve Tool

Replacement T-Handle Floor Sleeve Tool
00873900



00879000

Specialty Sleeves

- 00879000 Second Floor Installation Sleeve
Use in addition to any sleeve on this page for 2nd floor installations.

- Outdoor Sleeves
- 00402000 2³/₈"
- 00403000 3¹/₂"



T-Base Standards

The perfect choice for second floor situations when the installation of sleeves is impossible. The compact T-shaped steel base holds 3¹/₂" O.D. standards and provides a three-point, tripod type support with an upright sleeve and tubular gusset to eliminate the need for additional cables or bracing. Available option for Powr-Rib II, Powr-Line, Powr-Trak, and Economy standards. Each T-base require two floor anchors.

- BASE00102001 T-Base w/ Hand Wheel Kit
- HAND00087000 Hand Wheel Kit Only

PORTABLE STANDARDS REQUIRE ANCHORS

GAME STANDARDS



Badminton Standards

Durable 2³/₈" OD powder-coated steel tube uprights are designed for use both inside and outside. Uprights are provided with competition quality top cap guide and net tie-off hardware. Pickleball compatible.

Available as a portable unit. Portable units include heavy T-shaped steel bases with non-marking, anti slip rubber feet for stability without use of floor anchors. Each base has two 3" diameter casters. Net and floor sleeves are not included.

- 764100 Sleeved End Standards
- 764150 Sleeved Center Standard
- 779000 Portable End Standards

Badminton Net

Black mesh net with 1" openings. Net is furnished with attachment cords of sufficient length for use on volleyball standards with 36' centers when desired.

2236110

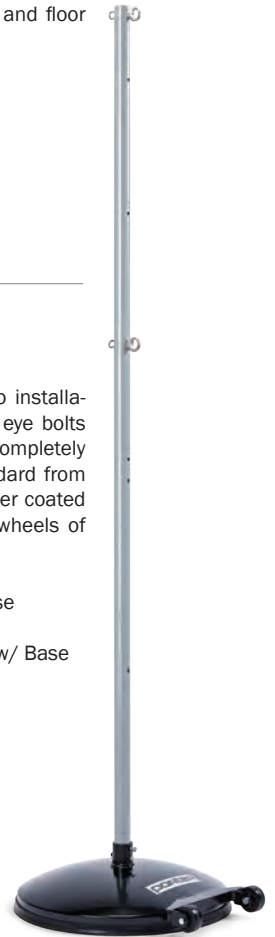

Combination Game Standards

These cableless sleeve type game standards are perfect for indoor or outdoor fun and recreation. Standards are 2³/₈" OD galvanized for years of durability. Settings for competition badminton, men's and women's volleyball and/or tennis are provided. End and center standards are furnished with ratchet type tensioning reel.

- 761100 End Standards
- 762100 Center Standard
- 00402000 Outdoor Ground Sleeve
- 02254000 Intramural Volleyball Net
- 2236110 Badminton Net
- 02991340 P.E. Tennis Net

Weighted Base Game Standards

Tip it and roll it away! It's that easy to transport. No installation necessary. The steel standard is complete with eye bolts and eye nuts. Non-marking rubber protection ring completely encircles 145 lb domed steel base, preventing standard from sliding and floors from being damaged. Base is powder coated gloss black. Frictionless 3" diameter silent-bearing wheels of gray non-marking synthetic provide effortless mobility.

- 00431000 Volleyball/Badminton Standards w/ Base
Accommodates No. 02254000 volleyball and No. 2236110 badminton nets
- 00431100 Volleyball/Badminton Center Standard w/ Base
- 02201100 Reel for Volleyball/Badminton Standard
- BASE00006 Portable Base Only (No Upright)

Net Tensioning Cords

Tough virgin natural rubber cords provide needed tension for nets. "S" hooks attach to ends for easy use. Recommended for use with weighted type game standards. (Not Shown).

00435000



Wood Floor Anchor

3¹/₂" diameter chrome-plated cover with #14 x 1¹/₂" installation screws.

00242000



Grout Type Anchor

Max. 1¹/₄" in total finished floor thickness above concrete sub floor. 1¹/₂" diameter by 3³/₄" length. Chrome anchor top.

00243000



Thin Concrete Anchor

Four double acting expansion anchors provide a pull-out load of 8,200 lbs. Top plate is 3¹/₂" diameter, chrome plated.

00242100



Cast-In-Slab Anchor

1¹/₄" in total floor thickness above concrete sub floor.

00247000



Sleeper Anchor

Threaded top plate is 3¹/₂" diameter to provide adjustment to floor surface.

00244000



Expansion Anchor

Ideal with at least 6" of concrete. Anchor is 1¹/₂" diameter. Washers may be added or removed to keep surface of anchor flush with floor.

00247100



**WE DO
IMPOSSIBLE.**



FACILITIES

FORMFOLD SERIES

FORMFOLD SERIES    

5065

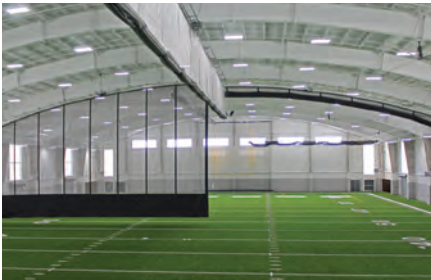

Divider Curtains

These curtains can be composed of any combination of vinyl, mesh, and/or netting materials and can be fabricated to any size. The powerful, single motor system eliminates intricate synchronizer devices found in other large curtain designs. Designs can conform to peak slopes, arches, or single slopes when retracted for maximum clearance

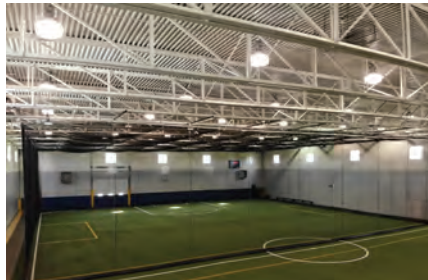

Perimeter Shell Systems

Operable system can be composed of any combination of vinyl, mesh, and/or netting materials. The flexible pulley and cable design eliminates mechanical line shaft components, which can reduce costs and installation time in complex building structures. This is a great option to contain lacrosse balls or baseballs in a large field of space.



Batting Cages

These cages are designed to conform to peak slopes, arches, or single slopes when retracted for maximum clearance. Custom cage sizes and multiple net options are available. Can include separate intermediate dividers to convert the cage from a larger practice space to a more traditional batting tunnel setup.

FORM SERIES

The FORMFOLD series is unlike any other line of athletic facility equipment on the market today. Patented form fold technology can be adapted to a number of operable facility products such as divider curtain, batting cages, perimeter net systems, and more!

Form fold products can fold to a variety of unique roof contours to provide maximum clearance for play when stored. These systems will extend and retract up to 5 times faster than traditional curtains and cages, saving operators substantial time during setup. Form fold products can be constructed to fit facilities of any size, including regulation size soccer and football field house facilities.

- COMPOSED OF VINYL OR MESH AND/OR NETTING
- CUSTOM CAGE SIZES AND MULTIPLE NET OPTIONS
- CONFORMS TO ANY SLOPE OR CONTOUR

 **1** YEAR LIMITED WARRANTY



FORMS TO ANY SLOPE OR CONTOUR



FACILITIES OF ANY SIZE



30+ FT/MIN SPEED



CUSTOM GRAPHICS AVAILABLE

2080 CENTER ROLL®

CENTER ROLL CONFIGURATIONS

54

WALL GUIDED

- 2081 Single Motor
- 2084 Dual Motor

TORQUE ARM

- 2082 Single Motor
- 2085 Dual Motor



CENTER-ROLL

State of the art design that offers unprecedented operating speeds while eliminating fabric stresses.



One or both ends of lower fabric (below 3" dia. batten) may be cutback to allow for walkway, bleachers, etc.



30+ FT/MIN SPEED



CUSTOM GRAPHICS AVAILABLE

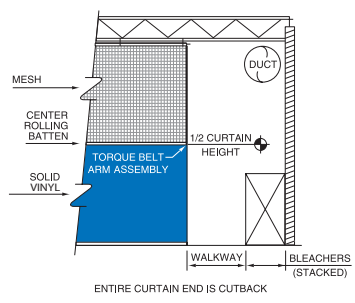
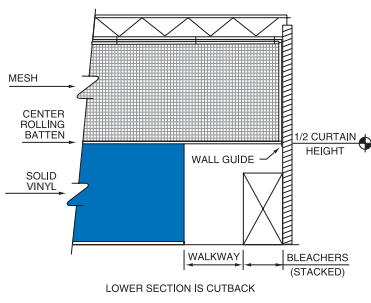

2080
SERIES

With no more hoist cables, straps or overhead support rollers, the 2080 SERIES CENTER-ROLL curtain is the finest divider curtain available for today's modern gymnasium and field house applications. Our lineup of divider curtain products help owners support multi-sport solutions and versatile programming within their facility spaces.

As the aluminum tube rotates, it moves the curtain up, rolling up the top and bottom sections simultaneously. This design allows the Center-Roll to roll up twice as quickly as a standard curtain. The assembly is extremely quiet, features automatic overheating protection, and is permanently lubricated for a maintenance-free operation. The Center-Roll curtain rolls neatly and compactly to within 14" of the ceiling or overhead support structure for maximum clearance. When support structures allow, the curtain will roll up through a one-foot wide opening and store above ceiling areas to further enhance the aesthetics of your installation. The Center-Roll can be designed with special openings for bleachers and passageways. It may also be specified as a dual-wall divider curtain incorporating wall-guide drive assemblies. Curtains come available in solid and mesh, all solid, or all mesh finish.

 **5** YEAR LIMITED WARRANTY

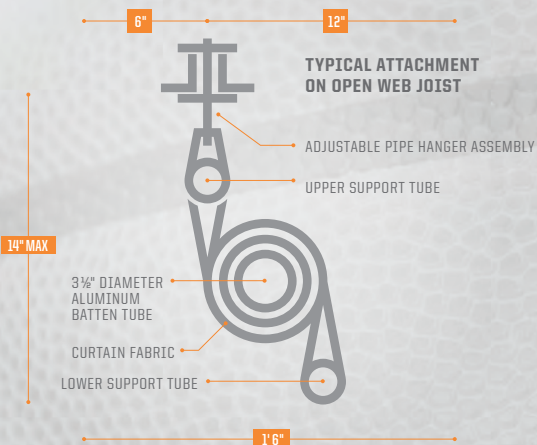

NETTING SYSTEMS



CALL TODAY!

Let our experts help you get the netting system that best fits **your facility**.



Track-Type Walk Draw Curtain

This divider curtain can be easily operated and stacked in the smallest of building recesses or stored flat against a wall. The curtain track is enclosed and is designed with a formed channel to protect the rollers from collecting dust and dirt particles that could hinder smooth operation. Each foot of curtain length requires 1" of stack area. The curtain can be provided as a single section or in bi-parting sections. Standard 2' radius curved track pieces are available for additional track customization. Available in solid and mesh, all solid, all mesh, or netting finish.

640
640N

Standard
Net

 **1** YEAR LIMITED WARRANTY

Vinyl Colors:

01 LIGHT BLUE	02 ROYAL BLUE	03 RED	04 WHITE	05 ORANGE	06 YELLOW GOLD	08 TAN
09 GRAY	10 MAROON	11 PURPLE	12 BLACK	13 NAVY BLUE	14 KELLY GREEN	15 DARK GREEN

Vinyl-Coated Mesh Colors:

 WHITE	 ROYAL BLUE	 RED	 GRAY	 BLACK
---	--	--	--	---

Vinyl coated Mesh provides an approximate 45%-50% open air breathing area allowing both light & air transfer.



TRACK TYPE WALK-DRAW

A system that is easy to operate and simple to maintain, with a design that fits countless applications.

ROLL-UP CURTAIN



ROLL-UP

A strong and durable curtain style, with rolling belts and a striking appearance.



Roll Up Curtain

Featuring the strongest, most durable curtain-hoisting system available, the Roll Up Curtain maintains its smooth, wrinkle-free surface even when rolled up into a compact two feet for maximum clearance. Its clean design withstands the demands of today's high-use facilities. Aluminum trim neatly finishes the curtain's bottom hem, helping to preserve and enhance overall appearance. The curtain is conveniently raised and lowered by means of a maintenance-free hoist system. The curtain can be controlled by Porter's standard key switch, optional Powr-Touch systems or Sportsonic remote system. Available in solid and mesh, all solid, or all mesh.

675 Standard Curtain

1 YEAR LIMITED WARRANTY

RAPIDLIFT® CAPABLE

SOLD SEPARATELY

10795000 Line Shaft Safety Lock

Custom Graphics Also Available On All Porter Divider Curtains.

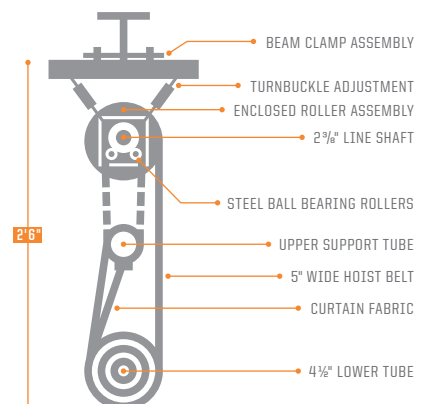

FOLD-UP CURTAIN

58



Standard Fold-Up Curtain

The standard Fold-Up curtain offers facilities a convenient means of dividing gymnasium space and yet provides an uncluttered appearance overhead. The economical design is hoisted by aircraft cables which pass through grommet cable guides. Available in solid and mesh, all solid, all mesh, or netting finish.

670
670N

Standard
Net



SOLD SEPARATELY

10795000

Line Shaft Safety Lock

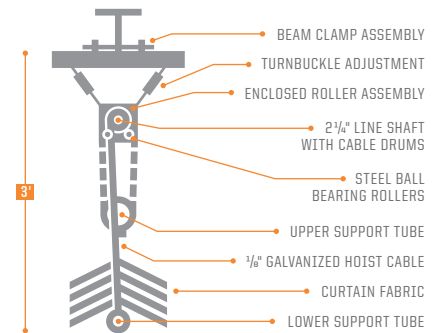

FOLD-UP

Convenience, economy, and a functional design make this style an extremely popular choice.

Standard Slope Fold Curtain

Designed to make the best use of ceiling space in sloped frame structures, the Slope-Fold curtain can be designed and installed to fit flush against the roof frame, providing maximum clearance for competition volleyball or basketball. Each slope fold curtain is custom-designed to fit the form of the facility. Both single sloping and peak sloped options are available. The electric winch system includes a custom engineered variable diameter ratio system which hoists the divider to the storage position and conforms to the existing slope of the facility.

665

 1 YEAR LIMITED WARRANTY

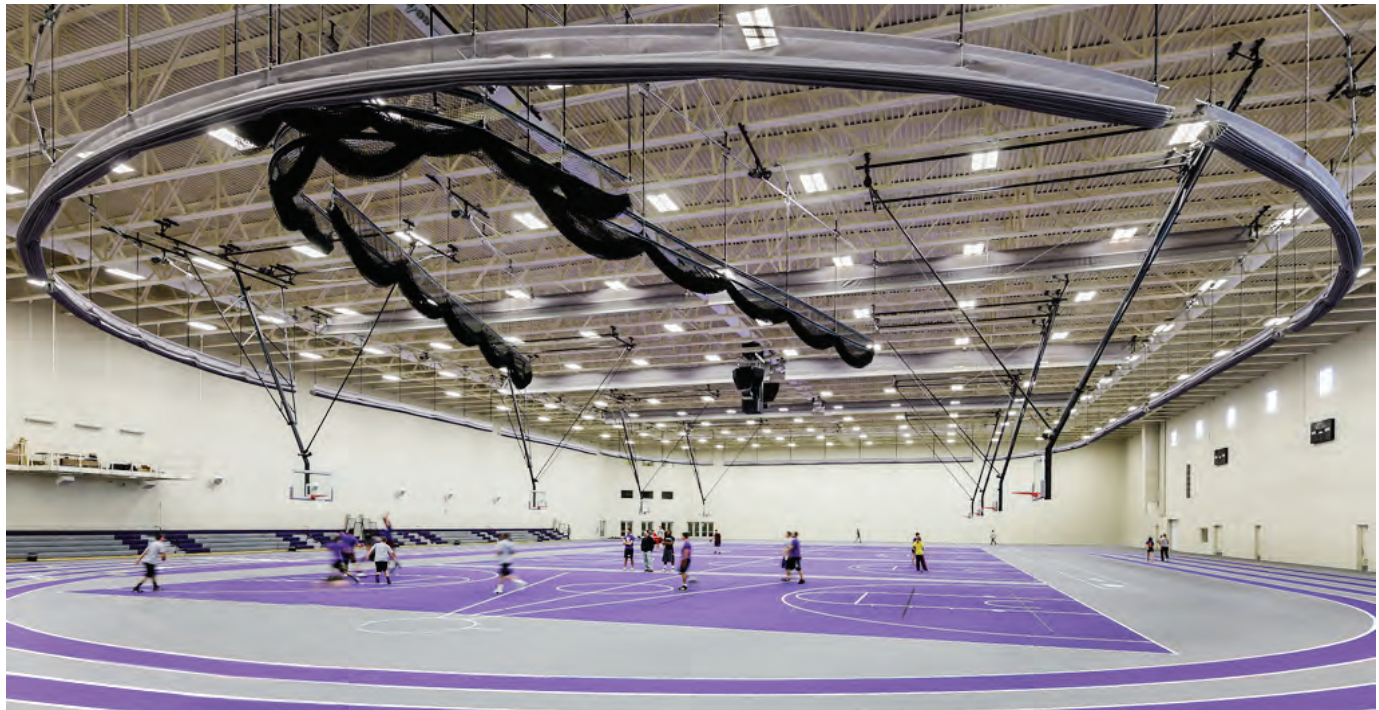

Perimeter Fold-Up Curtain

The unique design of the perimeter curtain provides a great way to accommodate curved radius applications, particularly around indoor running tracks. Porter custom-engineers and factory bends the curtain support tubes to match the contours of your facility design. Available in solid and mesh, all solid, all mesh, or netting finish.

690

INDOOR CAGES

60

Ceiling Suspended Throwing Cage

A must for indoor track and field facilities! Now with the turn of a key or push of a button, the cage and doors can be raised or lowered to the correct position. Facilities will no longer waste time moving around portable bases, uprights, heavy ballast containers and hoist netting. No need for large storage areas that take up valuable floor space.

The entire cage stores within 3' of the ceiling and descends by electric operation. The Ceiling Suspended Throwing Cage can be used as a shot put cage or an indoor throwing cage for the weight throw. This system safely protects athletes and officials from errant throws.

Meets and exceeds NCAA and USATF.

90732280

 **1** YEAR LIMITED WARRANTY



FEATURING **GILL**
ATHLETICS

**OUTDOOR
FACILITIES**

SEE PAGES 76-82

FACILITIES



Indoor Bottom Lift Batting Cage

Unlike standard batting cage systems, Porter's indoor bottom lift batting cage eliminates the tedious task of manually lifting the cage netting on top of the perimeter frame before raising it to the storage position, saving time and facility resources. Conversely, the cage is automatically stopped at its preset height setting ready for play without any other setup requirements. 3/4" square black mesh netting.

90920201 12' x 12' x 70'

90920400 13' x 12' x 70'

* Includes optional Bottom Tube + Zipper Entry.



Optional Zippered Entrance



Optional Bottom Frame

1 YEAR LIMITED WARRANTY

Ceiling Suspended Batting/Golf Cage

Porter's overhead-supported, electrically retractable batting/golf cages provide a superior product with ease of installation and reduced maintenance. The batting/golf cage is furnished standard with black 7/8" square mesh netting which provides players a higher level of contrast between the ball and the netting. Net can be stored on top of the support framework for compact storage.

90920000 12' x 12' x 70'

90920100 14' x 14' x 70'

90920002 12' x 24' x 70'

1 YEAR LIMITED WARRANTY



Walk Draw Suspended Batting Cage

Porter's Walk-Draw Suspended Batting Cage is an ideal solution for maximizing space in mezzanines or other gymnasium locations with low ceiling heights. This economical netting cage is suspended by a track-supported system that may be suspended from the ceiling structure. Roller carriers allow the batting cage to be easily extended or retracted along the track system. Cage netting stores neatly against a wall when not in use.

920640

1 YEAR LIMITED WARRANTY



RAPIDLIFT®

62

RAPID-LIFT®

BACKSTOP WINCH

708060 Low Torque
708100 High Torque

CURTAIN WINCH

XCUR708060 Low Torque
XCUR708100 High Torque



FACILITIES OF ANY SIZE



30+ FT/MIN SPEED



WHEN FAST MATTERS

	PORTER STANDARD SERIES WINCH	PORTER RAPIDLIFT
Facility Type	School Gymnasium	High-Volume Play
Power	¾ HP 120V, Single-Phase	3 HP, 208V, 3-Phase
Gear Ratio	150:1	60:1
Drive Type	Belt Drive	Direct Drive w/ VFD
Line Speed	12.9 ft/min	40 ft/min BACKSTOP 30 ft/min CURTAIN

"The NEW Rapid-Lift winch hoist offered by Porter will substantially cut down on event turnover time for facilities who host multiple practices, games, and events each day."

- Coach Typer

FACILITIES

RAPID LIFT®

PORTER®

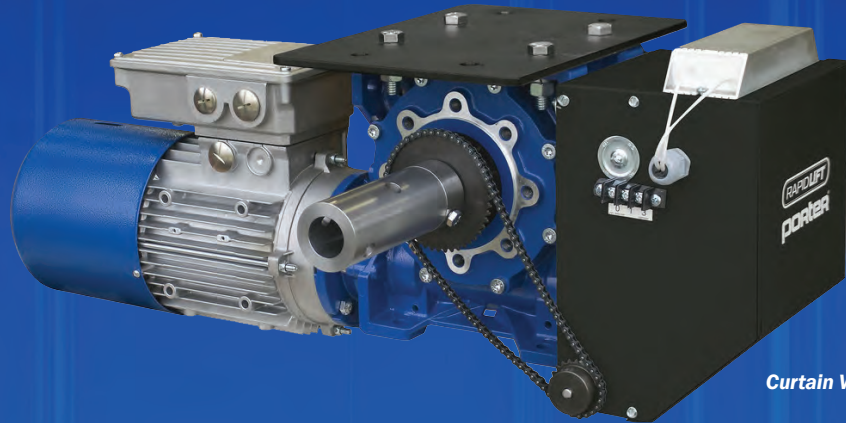

Curtain Winch



Backstop Winch

RAPID SERIES

Whether it's hosting multiple practices or transitioning between tournament events, drastically reduce the setup turnover with Porter's new RAPID series winches.

The Porter RAPID-LIFT® Backstop and Curtain Winch is engineered to quickly turnover a high-capacity facility to the next activity. Traditional Winches are a functional solution for most standard gymnasiums, however for facilities who host back-to-back events where quickness matters, RAPID-LIFT is the solution. RAPID-LIFT winches can safely lift a backstop or curtain up to three times faster than traditional winches. VFD Technology allows the winch to ramp-up and ramp down in speed during the beginning and end of the operation cycle, creating safer performance and drastically reducing any mechanical stresses on the equipment during operation.

- BACKSTOP LIFT SPEED UP TO 40' PER MINUTE
- CURTAIN LIFT SPEED 30' PER MINUTE
- VFD (VARIABLE FREQUENCY DRIVE)
- 208VAC, 3-PHASE 60HZ ELECTRIC MOTOR
- 3 HP MOTOR WITH 17 FT/LB BRAKE
- HEAVY GAUGE POWDER COATED STEEL FRAME

 5 YEAR LIMITED WARRANTY





POWR-TOUCH® 5

Powr-Touch® 5   

12800000 Wireless Control System

64

PT5 System Features:

-  Wireless Capability
-  4 Digit Security Code
-  Programmable "Quick Courts"
-  "Zoned" Screen Control
-  Simultaneous Up/Down Operation
-  Customized Graphical Interface
-  Optional Fixed Panel-Mounted Touchscreen



WIRELESS CAPABLE



SIMULTANEOUS UP / DOWN



MULTI-FUNCTION OPERATION



To View a Court Demo or See Powr-Touch in Action, Contact Your Porter Dealer.



THE ULTIMATE GYM CONTROL SYSTEM

FACILITIES



PT5
SERIES

The most innovative, yet intuitively simple system control in the industry today. Fully optimized for wireless control with proprietary S.C.O.R.E. Technology that offers total functionality at your fingertips.

Powr-Touch® 5 is a wireless enabled custom graphic control interface designed to work on a computer, a tablet, or other network enabled device capable of supporting an html browser. Its wireless capability provides unprecedented function, flexibility, and safety in the management of your athletic facility. Powr-Touch 5 presents the ultimate gymnasium control system.

- WIRELESS CAPABILITY
- PROGRAMMABLE "QUICK COURTS"
- "ZONED" SCREEN CONTROL
- S.C.O.R.E. TECHNOLOGY
- SIMULTANEOUS UP/DOWN OPERATION
- CUSTOMIZED GRAPHIC INTERFACE

COMPATIBLE WITH



 **1** YEAR LIMITED WARRANTY

POWR-TOUCH® 4

Powr-Touch® 4 Control System

66

The Powr-Touch® 4.0 is an LCD touchscreen control system designed with the user in mind. With a 7" full-color graphic interface and intuitive layout the Powr-Touch 4.0 allows you to easily jump in and drive. The option to personalize equipment names and settings will give you full control of your equipment while reducing initial set up time.

The ability for simultaneous operation of several types of equipment, each in opposite directions allows for rapid facility change-over. Effortless navigation and extensive capabilities lead to unprecedented performance. System is compatible with Powr-Touch® 2.5 Equipment Control Panels.

12700000
12555200

Powr-Touch® 4 Touch Screen
Powr-Touch® 4 Equipment Control Panel

-  7" Full Color Touch Screen
-  Controls up to 128 Devices and 32 Auxiliaries
-  Operate 64 Devices Simultaneously
-  Programmable "Quick Courts"
-  Simultaneous Up and Down Operation
-  Link up to 7 Total Screens
-  4 Digit Security Code for Both User and Administrator

 **1** YEAR LIMITED WARRANTY

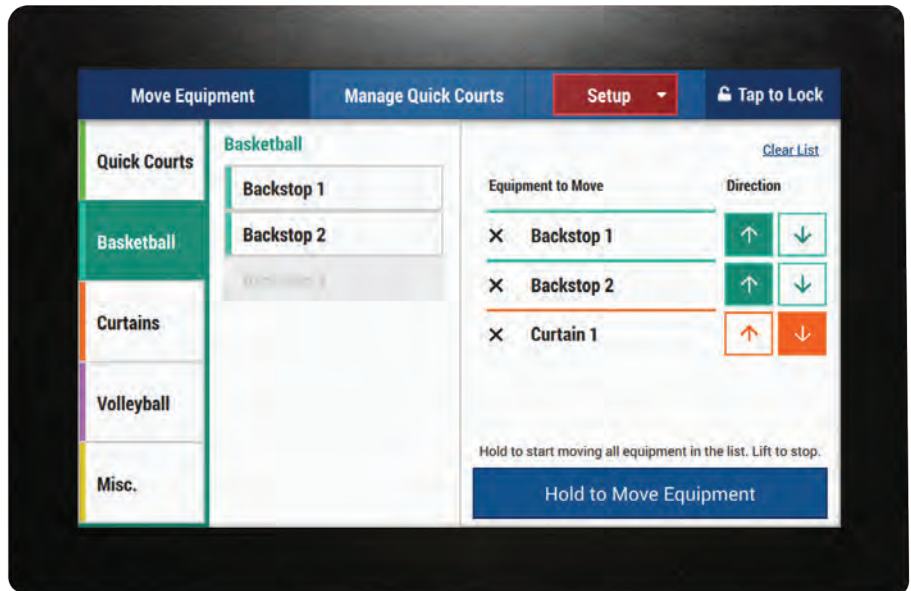

To View a Court Demo or See Powr-Touch in Action, Contact Your Porter Dealer.

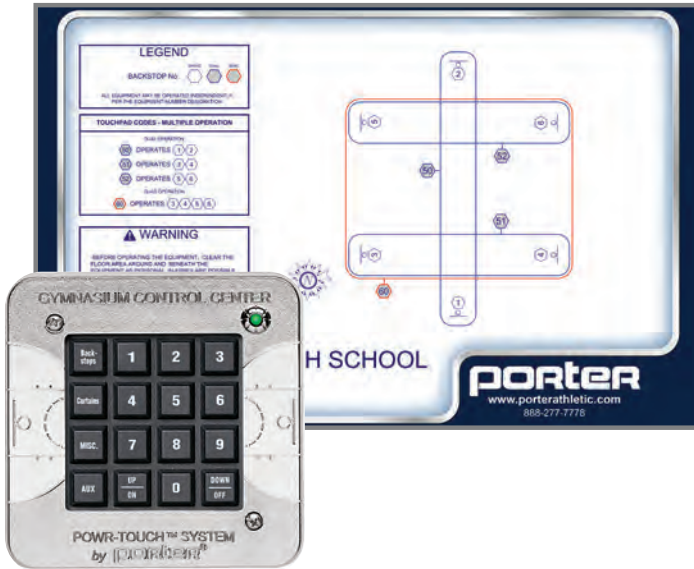

Powr-Touch® 2.5







Substantially reduce gymnasium design costs, while also cutting setup time required for raising and lowering equipment. There's no need to keep track of keys or take the time to control equipment individually.

The Powr-Touch® 2.5 enables you to raise or lower up to eight backstops, four divider curtains, or other gymnasium equipment simultaneously from any installed TouchPad. Specify multiple TouchPads when equipment operations from various locations within the gym are required. Powr Touch 2.5 system is available with Porter's Custom Graphical Equipment Legend., which allows the user to identify each piece of equipment. System offers password protection to prevent unauthorized access and can substantially reduce electrical wiring and circuitry costs.

 **1** YEAR LIMITED WARRANTY

12555100
12555200

Powr-Touch® 2.5 Touch Pad
Powr-Touch® 2.5 Equipment Control Panel

	SERVICEABILITY	SYSTEM PROGRAMMING	CONTROL INTERFACE
 Powr-Touch® 5 	Remote Support	Factory Programmed	Portable Tablet 12.1" Fixed LCD Screen
 Powr-Touch® 4 	System Backup to USB	User Programmed	7" LCD wall-mounted Touchscreen
 Powr-Touch® 2.5 	N/A	User Programmed	4" wall-mounted Touchpad

Key Switch Control



This control system provides separate up and down keys for safe equipment operation. Standard 4½" square flush mounting features a stainless steel cover plate.

1 key switch per device is required.

[XELE00791112](#)



SportSonic® II

SportSonic® II Transmitter operates up to 99 pieces of equipment effortlessly via remote control. An excellent choice where maneuverability and convenience are desired while operating the gymnasium equipment. Reduces the need for costly wiring and key switches.

1 receiver per backstop is required.

[12002100](#) SportSonic II Transmitter
[12002200](#) Receiver Kit

MAT MOVER[®] SERIES



Mat Mover[®]

Return valuable floor space to your facility and protect your wrestling mats or lightweight cheerleading mats with an 1100 Series Mat Mover from Porter. The Mat Mover provides a wide array of design configurations and sling hoist options to fit the needs of your specific facility. Available sling sizes and configurations are capable of storing multiple 6ft or 14ft long mat sections.

Three distinct lifting modules, consisting of a single 3 HP motor drive unit and two lifting drum units, integrate into a streamlined design platform that will deliver long-lasting customer satisfaction. System includes a separate mounted control panel unit with main electrical disconnect switch, control circuit transformer, and audible motion safety alarm device. Audible motion alarm will alert athletes when the unit is in motion.

CEILING SUSPENDED

- 91107000 Single Stationary
- 91107002 Double Stationary

WALL MOUNTED

- 91107050 Single Stationary
- 91107052 Double Stationary

Power Requirements Options:

208 volt, 460 volt in 3 phase, 60hz.

Sling Configurations



SINGLE MAT IN ONE SLING



TWO MATS IN TWO SLINGS
(SIDE BY SIDE)



TWO MATS IN TWO SLINGS
(VERTICAL)



THREE MATS IN TWO SLINGS
(VERTICAL - MINI ONLY)

Stationary Mini Mat Mover[®]

The mini stationary unit can store one to three 14' x 42' mats. An audible motion alarm is furnished as standard and will alert athletes when unit is in motion. This single 1.5 H.P. motor system is ideal for storing 14ft long sectional wrestling mats.

- 91105100N Triple Stationary Mini





7 YEAR LIMITED WARRANTY

Floor Cover System

- ✔ Tough 19 oz Polyester-Reinforced Vinyl
- ✔ Meets NFPA 701, UL-214, and CA Fire Marshall Fire Requirements
- ✔ 7 Year Warranty Against Defects in Materials/Workmanship On Cover
- ✔ Passes ASTM E84: Class A

An economical way to use your gymnasium as a multi-use facility. Protects your floors and helps reduce maintenance and refinishing expenses. The Porter floor cover transport and storage cart provides a quick and easy method to install and remove floor covers over large areas, with only two people.

Simply roll the transport cart into position at one end of the floor and lock the non-marking 6" diameter swivel casters in place. Pull the 10' wide seamed sections across the floor and repeat for additional sections of cover as required. When removing, attach each cover section to individual storage rollers with quick and easy hook and loop attachment strips. Roll up the vinyl covers with the standard hand crank or optional power winder. No manual lifting required.

10' Standard Width Vinyl-Coated Floor Cover Fabric

Specify length and color when ordering. 120' max per roll.
92418XX 19 oz Vinyl

Transport/Storage Carts

Other sizes available online.

2404	4 Roller	(max. 40' x 120' / 4,800 ft ²)
2406	6 Roller	(max. 60' x 120' / 7,200 ft ²)
2408	8 Roller	(max. 80' x 120' / 9,600 ft ²)
2410	10 Roller	(max. 100' x 120' / 12,000 ft ²)
2412	12 Roller	(max. 120' x 120' / 14,400 ft ²)

SOLD SEPARATELY

02405000	Power Winder
924040XX	Storage Rack Cover
02406200	Hand Held Tape Applicator
02406300	Walk Type Tape Applicator
02406112	Tape (12 rolls)



Non-Marking Locking Casters



Optional Tape Applicators



Standard Hand Crank



Hook and Loop Attachment System



Optional Storage Cover



Optional Power Winder

Vinyl Colors:

01 LIGHT BLUE	02 ROYAL BLUE	03 RED	04 WHITE	05 ORANGE
06 YELLOW GOLD	08 TAN	09 GRAY	10 MAROON	11 PURPLE
11 PURPLE	12 BLACK	13 NAVY BLUE	14 KELLY GREEN	15 DARK GREEN

When Ordering: Use the two-digit color number to replace XX in the item number.

GYM EQUIPMENT & ROPES

70

Wall/Ceiling Mounted Chinning Bar



- ✓ 1" OD Grip
- ✓ Mounts 22" From Wall/Ceiling
- ✓ Black Powder Coat Finish
- ✓ Hardware Not Included

WE179

50" W x 21" T



Adjustable Chinning Bar

- ✓ 1" OD Grip
- ✓ Mounts 22" Away
- ✓ Hardware Not Included

00197100

50" W x 21" T



Multi-Station Wall-Mounted Chinning Bar



Great for mounting PowerMax TA1598 Fitness Rings or other popular suspension training systems!

00196013

10' 3 Piece Steel Chinning Bar

- ✓ 10' Long With Three Stations
- ✓ Mounts 16" Away
- ✓ 1" OD Solid Steel Grip & Durable Zinc Plated Finish



	Knotted End Hemp	Vinyl Boot End Collegiate	Ball/Knotted Hemp	Vinyl Boot End Dacron	Boot/Knotted Dacron
12' Long	00113120	00199012	00115120	00118120	00119120
16' Long	00113160	00199016	00115160	00118160	00119160
20' Long	00113200	00199020	00115200	00118200	00119200
24' Long	00113240	00199024	00115240	00118240	00119240

Hemp Climbing Ropes

This 1½" rope contains 12-18% mineral oil lubricant by weight for long life and is securely attached within a heavy-duty steel fitting for years of durability. Rubber knots (optional) anchored every 12". Collegiate ropes are finished with a vinyl boot.

Soft Dacron Ropes

Soft Dacron ropes are ideal for elementary physical education programs. The no-twist spun Dacron material is easier on hands than hemp ropes and will wear better than cotton. Hypoallergenic.

Rope Attachment Methods

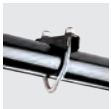

3½" OD Pipe Clamp

XCLP97001002



Staple Plate

10340000
10341000

For Wood Beams
For Concrete Beams



Steel I-Beam Clamp

10100100
10100200

Fits ≤8" Beams
Fits ≤17" Beams

Rope Accessories



Tambourine

3/8" lacquered plywood tambourine restricts climbing height. Clamp permits fast removal & easy adjustment.

00198000



Rope Hoist

Hoist is complete with wall brackets, ceiling attachment, heavy-duty cord and weight. Installs easily, ready to use.

00104000



Safety Guard

Safety guard prevents the rope from falling if a part fails or wears out.

00110000



Rope & Ring Storage Track

Designed to suspend and transport climbing ropes or ring apparatuses to a storage position against the wall for an uncluttered facility appearance. A heavy duty steel track with carriers and operable nylon rope pull system allows for easy operation. A maximum of four ropes may be suspended from one track system. Rope lock system is designed to securely lock a maximum of four climbing ropes to prevent use by unauthorized individuals. Porter climbing ropes sold separately.

9011700N
00117040

Storage Track
Optional Rope Lock System



SPECIALTY PADS



DURA SAFE



FIRE SAFE



SUPER SAFE



CONFIGURED COLUMN AND CORNER PADS

Pads configured to your specified dimensions for a custom fit on exposed wall corners or columns. Rigid backed pads are 2" polyethylene foam bonded to 7/16" wood board and covered in 19 oz vinyl. Sewn pads are 2" polyethylene foam covered in 15 oz vinyl. Available in 14 colors. 1" nailing margins on top and bottom for ease of installation. DuraSafe and SuperSafe pads meet ASTM F2440 impact protection. FireSafe and SuperSafe pads entire assembly is ASTM E-84 Class "A" fire rated and tested in accordance to meet IBC and NFPA 101 code requirement.

2 Sided Pads

2'x6' or less; worksheet required

- 90216026XX
- 90206026XX
- 90208026XX
- 90207026XX

- 2' x 6' DuraSafe™ Sewn
- 2' x 6' DuraSafe™ Rigid Backed
- 2' x 6' FireSafe™ Rigid Backed
- 2' x 6' SuperSafe™ Rigid Backed

4'x8' or less; worksheet required

- 90216048XX
- 90206048XX
- 90208048XX
- 90207048XX

- 4' x 8' DuraSafe™ Sewn
- 4' x 8' DuraSafe™ Rigid Backed
- 4' x 8' FireSafe™ Rigid Backed
- 4' x 8' SuperSafe™ Rigid Backed

3 Sided Pads

4'x8' or less; worksheet required

- 90316048XX
- 90306048XX
- 90308048XX
- 90307048XX

- DuraSafe™ Sewn
- DuraSafe™ Rigid Backed
- FireSafe™ Rigid Backed
- SuperSafe™ Rigid Backed



Wall and Panel Attachments



Wall and Channel Attachments

Wall Pad Mounting Clips

An attractive, convenient alternative to permanently attaching wall pads that will provide your facility with a clean, neat appearance. The Z-Clip securely locks wall panels in place and allows worn pads to be easily removed for repair or replacement.

- 347100
- 347200
- 347300

- Z-Clip Wall Attachment, 6'
- Z-Clip Panel Attachment, 1'10"
- Z-Clip Channel Attachment, 6'



"I" Beam Pad

6' tall pad with 2" polyethylene foam covered in 15 oz vinyl. Available in 14 colors. Attaches with hook and loop strips.

- 3560XX 6"-8" Wide Beams
- 3562XX 8"-10" Wide Beams
- 3563XX 10"-12" Wide Beams
- 4560XX 6"-8" SuperSafe™ Wide Beams
- 4562XX 8"-10" SuperSafe™ Wide Beams
- 4563XX 10"-12" SuperSafe™ Wide Beam



Molded Inserts

The perfect solution when cutouts are required for electrical outlets and switches. Inserts fit through field cutouts and are stapled in place on the backside of the pad. Inserts are molded in a flame-retardant rubber and accommodate pad thickness of 2-3". Available in two sizes to fit single-gang and double-gang electrical boxes.

Patent No. 6,769,562

Gray

- 343001 Single-Gang Gray
- 344001 Double-Gang Gray

Graphite

- 343101 Single-Gang Graphite
- 344101 Double-Gang Graphite

Vinyl Colors:



When Ordering: Use the 2-digit color number to replace XX in the item number.



Wall Pad Sleeve

Custom wall pad sleeve kits provide a finished appearance in wall pad installations when cutouts around large fixtures are necessary. Sleeve kits are easily installed through field cutouts in panels and are secured with staples on the backside of the pad. Sleeves are molded in a flame-retardant rubber. One kit includes four corner pieces and two 4' long side rails. Side rails may be cut to size in field to fit custom cutout applications. Insert kit fits all 2" thick Porter wall pads. Patent No. US10392815B1

Gray

90343001

Stage Pads



Pads configured to your specified dimensions for a custom fit. Panels are supplied in easily removable sections allowing easy set up and removal for stage activities or to access storage. Rigid-Backed pads are 2" polyurethane foam bonded to 7/16" wood board and covered with 19 oz vinyl. Sewn pads are polyethylene foam and are covered with 15 oz vinyl. Available in 14 stock colors.



CUSTOM GRAPHICS AVAILABLE

960550XX
960550XXSP

Sewn Pad
Sewn Pad With Graphics

960560XX
960560XXSP

DuraSafe™ Rigid Backed Pad
DuraSafe™ Rigid Backed Pad With Graphics

960570XX
960570XXSP

SuperSafe™ Rigid Backed Pad
SuperSafe™ Rigid Backed Pad With Graphics

960575XX
960575XXSP

FireSafe™ Rigid Backed Pad
FireSafe™ Rigid Backed Pad With Graphics

Storage Strip

1½" wide rigid hook and loop strip is encased in a 4' long anodized aluminum strip for ease of mounting.

14444

WALL PADS



All Porter Wall Pads feature:  **5** YEAR LIMITED WARRANTY

 CUSTOM GRAPHICS AVAILABLE

- Pads Available With ASTM F2440 Impact Protection And/Or ASTM NFPA 286 Certification
- Foam Bonded To 7/16" Oriented Strand Board (OSB)
- Entire Pad Upholstered In Heavy 19oz Vinyl
- Vinyl has a 100PSI Tensile Strength With Leather-like Finish
- Custom Graphic Printing And 14 Vinyl Colors Available
- Mildew And Rot Resistant
- Custom Sizes Available, Call For More Details



Custom Graphics Add **SP** to end of item #

Vinyl Colors:



When Ordering: Use the 2-digit color number to replace XX in the item number.

PAD FEATURES



DURA
SAFE



FIRE
SAFE



SUPER
SAFE



CUSTOM
GRAPHICS

Custom Graphics Add SP to end of item #



5 YEAR LIMITED WARRANTY

DuraSafe™ Pads

Basic Protection



- Meets ASTM F2440 Impact Protection Standard

2" Foam (Each)

5601XX	2' x 6' (No Margins)
5600XX	2' x 6' (Nailing Margins)
560281XX	2' x 8' (No Margins)
560280XX	2' x 8' (Nailing Margins)

3" Foam (Each)

5611XX	2' x 6' (No Margins)
5610XX	2' x 6' (Nailing Margins)

Custom Pad Dimensions (2" Foam)

9056026XX	2' x 6' or less
9056028XX	2' x 6' to 2' x 8' Custom
9056038XX	2' x 8' to 3' x 8' Custom
9056048XX	3' x 8' to 4' x 8' Custom

Custom Pad Dimensions (3" Foam)

9056126XX	2' x 6' or less
9056128XX	2' x 6' to 2' x 8' Custom
9056138XX	2' x 8' to 3' x 8' Custom
9056148XX	3' x 8' to 4' x 8' Custom



5 YEAR LIMITED WARRANTY

FireSafe™ Pads

Fire Protection



- Entire Pad Assembly is ASTM E-84 Class "A" Fire Rated
- Tested in accordance with NFPA 286 to meet IBC and NFPA 101 code requirements

2" Foam (Each)

5751XX	2' x 6' (No Margins)
5750XX	2' x 6' (Nailing Margins)
575281XX	2' x 8' (No Margins)
575280XX	2' x 8' (Nailing Margins)

3" Foam (Each)

5761XX	2' x 6' (No Margins)
5760XX	2' x 6' (Nailing Margins)

Custom Pad Dimensions (2" Foam)

9057526XX	2' x 6' or less
9057528XX	2' x 6' to 2' x 8' Custom
9057538XX	2' x 8' to 3' x 8' Custom
9057548XX	3' x 8' to 4' x 8' Custom

Custom Pad Dimensions (3" Foam)

9057626XX	2' x 6' or less
9057628XX	2' x 6' to 2' x 8' Custom
9057638XX	2' x 8' to 3' x 8' Custom
9057648XX	3' x 8' to 4' x 8' Custom



5 YEAR LIMITED WARRANTY

SuperSafe™ Pads

Advanced Protection



- Meets ASTM F2440 Impact Protection Standard
- Entire Pad Assembly is ASTM E-84 Class "A" Fire Rated
- Tested in accordance with NFPA 286 to meet IBC and NFPA 101 code requirements

2" Foam (Each)

5701XX	2' x 6' (No Margins)
5700XX	2' x 6' (Nailing Margins)
570281XX	2' x 8' (No Margins)
570280XX	2' x 8' (Nailing Margins)

3" Foam (Each)

5721XX	2' x 6' (No Margins)
5720XX	2' x 6' (Nailing Margins)

Custom Pad Dimensions (2" Foam)

9057026XX	2' x 6' or less
9057028XX	2' x 6' to 2' x 8' Custom
9057038XX	2' x 8' to 3' x 8' Custom
9057048XX	3' x 8' to 4' x 8' Custom

Custom Pad Dimensions (3" Foam)

9057226XX	2' x 6' or less
9057228XX	2' x 6' to 2' x 8' Custom
9057238XX	2' x 8' to 3' x 8' Custom
9057248XX	3' x 8' to 4' x 8' Custom

porter
FEATURING

76

GILL
ATHLETICS

**MAKING GREAT
EQUIPMENT
ISN'T EASY.
INSTALLING
IT SHOULD BE.**

Since 1918, Gill Athletics® has been equipping coaches with innovative equipment that elevates the sport and performance of athletes across the globe.



Gill hammer cages have exclusive features that protect athletes, officials, and spectators from errant throws in the hammer event. Combined with an industry best five-year warranty, Gill Athletics keeps your facility at the top of its class in safety and efficiency. Your facility deserves the best.

FRONT DOOR CABLE DESIGN

With Gill's exclusive tensioning cable front door design your cage will increase athlete safety and efficiency in the event. No more bent front pole from errant throws, and decrease the likelihood of bounce backs from implements.

DOOR HINGE LOCK BOLT

Suggested from the top track designer in America, this unique feature keeps your front doors from tweaking and misaligning from the door hatch location.

BLOCK & TACKLE PULLEYS

Block and tackle pulley system to safely remove 'stuck' implements from the nets without climbing.

REAR DOOR ACCESS

Netting System that keeps your athletes away from the throwing sector of the front cage while increasing the speed of repetitions.



On all Gill Cages
Call for Details.

CUSTOMIZABLE CAGES

Pole Color (XX)



Accent Color (YY)



*To specify your color selection, use the two-digit number to replace XX & YY in the item number.

HAMMER CAGES



NEW! PULLEY SYSTEM

NCAA HAMMER/DISCUS CAGES

- Available in single ring or double ring design
- Poles: 6063-T6 aluminum net poles
- Doors: Cages have 7m tall aluminum doors with galvanized steel door hinge poles. Tall Cages have 8m tall doors.
- Net: Weather treated nylon 6 net with 749 lb break strength
- Cage - Main net: 20' 6"/6.25m, Door net: 23'7m
- Tall Cage - Main net: 23'7m, Door net: 26' 3"/8m
- All cages include required cage door bracing.
- Ground sleeve kit sold separately
- **Meets NCAA specifications**
- **5 Year Warranty**

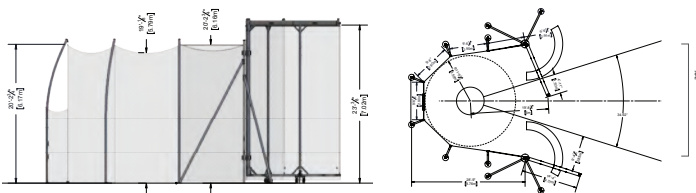

SINGLE RING CAGES

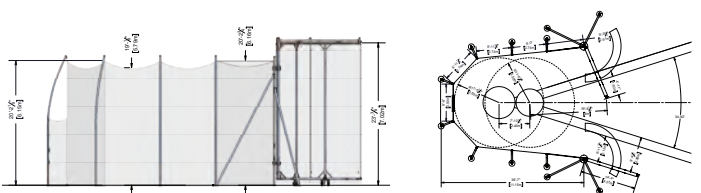

DOUBLE RING CAGES

SINGLE RING CAGE

742110	Cage
742110CXXYY	Cage with Custom Color
74211001	Ground Sleeve Kit
732103	Optional Barrier Net (8')

TALL SINGLE RING CAGE

742120	Tall Cage
742120CXXYY	Tall Cage with Custom Color
74212001	Ground Sleeve Kit
732103	Optional Barrier Net (8')

DOUBLE RING CAGE

742115	Cage
742115CXXYY	Cage with Custom Color
74211501	Ground Sleeve Kit
732108	Optional Barrier Net (8')

TALL DOUBLE RING CAGE

742125	Tall Cage
742125CXXYY	Tall Cage with Custom Color
74212501	Ground Sleeve Kit
732108	Optional Barrier Net (8')



CUSTOMIZABLE SYSTEMS

See color charts on page 72 to replace the XX and YY in the item numbers.

DISCUS CAGES

78



APOLLO DISCUS CAGE

- Poles: (3) Combination of steel and aluminum to withstand up to 62mph winds
- Net: 1 3/4" square mesh woven poly cord with 352 lb break strength
- Net height: 18'
- Net is secured by 14 hanging points and 8 rope anchors
- 36" deep ground sleeves
- *Meets NCAA and IAAF Specifications*
- *5 Year Warranty*

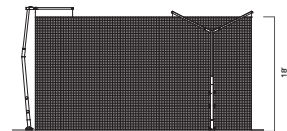
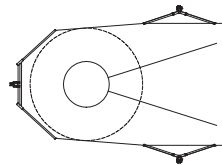

732301CXX *Apollo Discus Cage*

732301009 *Ground Sleeve and Net Anchor Kit*

COLORS



**To specify color with order, use the two-digit number of your color selection to replace XX in the item number.*



**On all Gill Cages
Call for Details.**



COLOR OPTIONS AVAILABLE!

Transform Your Cages with Custom Powder Coat

CUSTOMIZABLE



**To specify color with order, use the two-digit number of your color selection to replace XX in the item number.*

HIGH SCHOOL DISCUS CAGES

- Aluminum poles: 2 7/8" outside diameter 6063-T6 (Ultimate-30ksi, Yield-25ksi) with rolled offset for safety
- Steel poles: 2 1/2" square A513 (Ultimate-42ksi, Yield-30ksi) with rolled offset for safety
- Nets: 180 lb break strength
- Net height: 13' 6"
- *Meets NFHS specifications*
- *5 Year Warranty*

6 POLE DESIGN

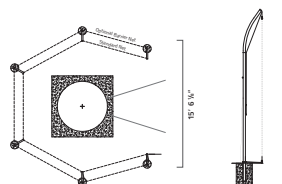

7 POLE DESIGN

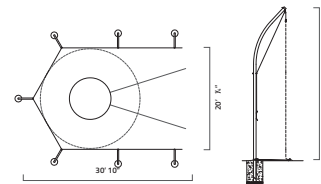

ALUMINUM CAGE

8010	6-Pole Cage
8010CXX	6-Pole Cage, Custom Color
80102	Barrier Net
8020	7-Pole Cage
8020CXX	7-Pole Cage, Custom Color
80202A	Barrier Net
8021	7-Pole Cage w/ Rear Door Access
8021CXX	7-Pole Cage w/ Rear Door Access, Custom Color
80212	Barrier Net w/ Rear Door Access

STEEL CAGE

8030	6-Pole Cage
80302	Barrier Net

BRUTUS CAGE

- For high wind areas that need extra strength discus cages
- Made of Hammer Cage strength 4" outside diameter aluminum poles
- *Meets NFHS specifications*
- *5 Year Warranty*

9010	6 Pole High School Cage
9010CXX	6 Pole High School Cage with Custom Color
9020	7 Pole High School Cage
9020CXX	7 Pole High School Cage with Custom Color
9021	7 Pole High School Cage, Rear Door Access
9021CXX	7 Pole High School Cage, Rear Door Access, Custom Color

CIRCLES & TOEBOARDS



ALUMINUM CIRCLES

- Four sections of 1" x 3/4" extruded aluminum angle
- Designed to be cast into concrete
- Discus circle can also be mounted to surface
- Compatible with toeboards 358, 363
- Meets NFHS, NCAA and IAAF specifications

369 Shot/Hammer Circle

370 Discus Circle



PROFILE FOR
369 & 370

ALUMINUM CIRCLES WITH CROSS BRACING

- Two sections of 1/4" x 3" extruded aluminum with welded bracing
- Bolt together to maintain form during in-ground installation
- Hardware included
- Compatible with toeboards 358, 363
- Meets NFHS, NCAA and IAAF specifications, IAAF certified

366 Shot/Hammer Circle 

366C04 Shot/Hammer Circle; white 

367 Discus Circle 

367C04 Discus Circle; white 



SYNTHETIC SHOT TOEBOARD FOR DEPRESSED PAD

- Molded low density polyethylene designed for 3/4" depressed surface
- Compatible with circles 366, 369, 374, 3741
- Meets NFHS, NCAA and IAAF specifications

358

SYNTHETIC SHOT TOEBOARD FOR LEVEL PAD

- Molded low density polyethylene designed for surface mount shot circles
- Compatible with circles 372, 373
- Meets NFHS specifications

359

ALUMINUM SHOT TOEBOARD FOR DEPRESSED PAD

- Cast aluminum designed for a 3/4" depressed surface
- Compatible with circles 366, 369, 374, 3741
- Meets NFHS, NCAA and IAAF specifications, IAAF certified

363

ALUMINUM SHOT TOEBOARD FOR LEVEL PAD

- Cast aluminum designed for surface mount shot circles
- Compatible with circles 372, 373
- Meets NFHS specifications

364

TAKE-OFF BOARDS & VAULT BOXES



4350S

LAUNCH HARD WITH GILL BOARDS

ADJUSTABLE TAKE-OFF BOARD SYSTEMS

With the Gill Adjustable Take-Off Board Systems you get ease of installation, ease of use and dependable peak performance.

Gill Take-Off Board systems are the easiest and fastest boards to install in the market. **Complete system** comes with installation tray, adjustable folded aluminum base, reversible long lasting take-off board and foul board, and functional blanking lid ready to accept track surfacing.

- 8" take-off board and 4" foul board creates 12" system
- Exclusive easy-adjust leveling system for both horizontal and vertical axis
- Composite for longer lifespan
- Composite boards made of Polyboard®, an environmentally friendly, waterproof material that will not split or crack while offering jumpers great grip
- Meets NFHS, NCAA and IAAF specifications

4350S Complete NCAA System

P435007 Replacement 4" NCAA Foul Board

P435005 Replacement 8" Take-Off Board

P435205 Replacement 12" Take-Off Board

4352S 12" Take-Off Board and Tray

ALUMINUM VAULT BOX

- Welded aluminum construction
- Reinforced backstop for prolonged life
- Meets NFHS, NCAA and IAAF specifications, IAAF certified

502 

ALUMINUM VAULT BOX LID

- Compatible with all Gill vault boxes
- Reinforced with two ½" angled vertical supports to prevent sagging
- 50201: Recessed design to accommodate ½" (12mm) track surface
- 50202: Flush design with no added track surface

50201 Lid-Recessed Mount

50202 Lid-Flush Mount



SANDPIT FORMS & COVERS

Sand pit forms hold more than just sand, they hold value.

With four different options of Sand Catcher locations and two practical Sand Catcher Cover options, you can design the horizontal jump facility that will perfectly meet your needs.

No matter which combination you choose; with the Gill Functional-Form, you can rest assured it's the finest product (with the easiest installation) available.

Choose from one of two Sand Catcher Cover systems: traditional grate and mat or Gill (exclusive) Recessed Lid. When you consider the main function of a Sand Catcher system is not to catch sand but to store it, the Recessed Lid system is rapidly becoming the choice of facilities worldwide, as it is designed to receive track surfacing to match your track facility. When coupled with the 730148 Aluminum Sand Pit Cover, a complete logical design emerges for your world class jumps facility.

Choose from one of four sand catcher locations: no sides, two sides, two sides and back, or all four sides. Choosing Sand Catchers on the sides will cut unnecessary costs and eliminate potential trip hazards, providing more than ample storage space for overflow sand.

FORM WITH RECESSED CATCHERS



FORM WITH GRATE & MAT CATCHERS

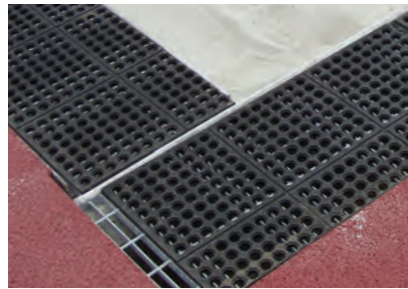

FORM WITH NO CATCHERS



Padding sold separately

4 SIDES	25' L	F46225
	28' L	F46228
	31' L	F46231
3 SIDES	24' L	F46124
	27' L	F46127
	30' L	F46130
2 SIDES	23' L	F46023
	26' L	F46026
	29' L	F46029

4 SIDES	25' L	F44225
	28' L	F44228
	31' L	F44231
3 SIDES	24' L	F44124
	27' L	F44127
	30' L	F44130
2 SIDES	23' L	F44023
	26' L	F44026
	29' L	F44029

LEDGE	23' L	F42023
	26' L	F42026
	29' L	F42029

ALL FORMS ARE 9' 8" WIDE

FAST INSTALLATION

**Track surface not included

READY-FIT ALUMINUM SAND PIT COVERS

F44023C	23' Cover
F44124C	24' Cover
F44225C	25' Cover

F44026C	26' Cover
F44127C	27' Cover
F44228C	28' Cover

F44029C	29' Cover
F44130C	30' Cover
F44231C	31' Cover

GILL[®]
ATHLETICS

MORE THAN TRACK & FIELD

*Your preferred source for track & field equipment is
also your source for football, soccer, baseball and more.
Quality. Commitment. Innovation.*

**FOOTBALL • SOCCER • BASEBALL
TENNIS • WINDSCREENS • PADDING**

BALLSTOPS

12' - 40' TALL BALLSTOP SYSTEMS

- 12', 15' and 20' use 4" diameter, 1/8" wall aluminum tube - #36 Netting
- 25' and 30' use 6" Sch 40 aluminum tube - #36 Netting
- 35' and 40' use 6" Sch 40 steel tube - #36 Netting
- All Poles 12'-40' have a vertical support cable for additional net support
- Ground sleeves included
- *All poles are powder coated in architectural black - Other colors available*
- *5 Year Warranty*

84

HERE FOR YOU!

CALL TODAY AND WE'LL HELP GET THE **BALLSTOP** SYSTEM THAT BEST FITS YOUR FACILITY.



On all Gill Ballstops
Call for Details.



**CUSTOMIZABLE
BALLSTOPS**

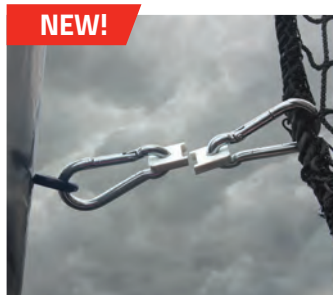

NEW!

BALLSTOP NET RELEASE CLIPS

Designed to drop the protective netting in high winds before any pole or hardware failure occurs.

- Marine Grade HDPE material
- Designed to break and drop nets in high winds, 20' and shorter or 25' and taller
- Sold in pack of 10 clips

739000 20' Ballstops and shorter

739001 25' Ballstops and taller



8062

10' TALL BALLSTOP SYSTEMS

The 10' Tall Ballstop Systems were designed to be set up and removed as needed and are available as above ground or in ground installation.

- Net: #504 Weather treated 1 3/16" square mesh with 1/4" roped edge and 180 lb break strength
- Net is supported at the top and held in place at the bottom by 1/8" vinyl covered steel cable
- The 8062 is a portable system which uses a platform base with wheels that is weighted down by four 5 gallon jugs (included)
- The 807 is installed in aluminum ground sleeves (caps are included for use when poles are removed)
- *Purchase one starter unit and as many additional units as needed to reach your desired overall length (Sold in 20' lengths)*
- *All poles are now powder coated in architectural black - Other colors available for an additional cost*
- *5 Year Warranty*

8062 Portable Starter Unit (10' x 20')

8062A Portable Additional Unit (10' x 20')

807 Sleeved Starter Unit (10' x 20')

807A Sleeved Additional Unit (10' x 20')

SHELTERS

PORTABLE TRACK SHELTER

Steel frame is mounted on swivel casters. 360 degree seating surrounds a center storage shelf. Roof frame is constructed of aluminum bracing with architectural gray powder coat. Canopy is tensioned with a one-piece vinyl wrap. Custom color and graphic application available on canopy top.

54240CXXSP *Portable Track Shelter w/ Graphics*



CUSTOMIZABLE

Vinyl



*To specify color with order, use the two-digit number of your color selection to replace XX in the item number.

VERSACOM BOXES

CONNECTING IT ALL TOGETHER

The *VersaCom Box* provides a junction for electricity and cable hookups. This box can be put in virtually any location around performance areas of varying surfaces. The open bottom of the *VersaCom Box* provides adequate drainage and conduit entry, while the hand holes in the cover allow easy access.

- Divider plates in full size version, provided to help keep electrical equipment segregated
- Main box structure is made of 1/4" thick folded aluminum
- Lid is constructed of 1/4" aluminum plates for maximum support and durability

The *VersaCom Box - Synthetic Version* allows material to be bonded or poured onto the top of the lid to match the surrounding surface.

F910 *Full Size (30" L X 18" W X 14" D)*

F930 *Half Size (15" L X 18" W X 14" D)*

The *VersaCom Box - Turf Version* features a supplied aluminum top to allow artificial turf to be glued on the jobsite, and is tethered to the box. This top is reinforced with multiple aluminum plates for maximum strength and durability. Factory installed turf infill retention brushes keep infill out of the box.

F960 *Full Size (30" L X 18" W X 14" D)*

F970 *Half Size (15" L X 18" W X 14" D)*



BENCHES & BLEACHERS

Benches are aluminum planking attached to heavy steel support frames. Benchseat is 10" wide and available with a powder-coat finish. Seats are 16" high and include back support.

- Non-Slip, Grooved Type Top Surface With Reinforcing Ribs
- 10" Wide Aluminum Alloy Planks
- Galvanized Structural Steel Support Frames
- Plank Ends Are Fitted With Die-Cut Formed Caps

ALUMINUM BENCHES WITH SHELF

74081	8' Bench, Aluminum Finish
74081CXX	8' Bench, Powder Coat
74161	16' Bench, Aluminum Finish
74161CXX	16' Bench, Powder Coat



74081



72081

ALUMINUM BENCHES

Portable Benches

72081	8' Bench, Aluminum Finish
72081CXX	8' Bench, Powder Coat
72161	16' Bench, Aluminum Finish
72161CXX	16' Bench, Powder Coat

Stationary (Ground Sleeve) Benches

72082	8' Bench, Aluminum Finish
72082CXX	8' Bench, Powder Coat
72162	16' Bench, Aluminum Finish
72162CXX	16' Bench, Powder Coat



74041C15

ALUMINUM BENCHES WITH BACKREST

Portable Benches

74041C15	4' Tennis Bench, Powder Coat
73081	8' Bench, Aluminum Finish
73081CXX	8' Bench, Powder Coat
73161	16' Bench, Powder Coat
73161CXX	16' Bench, Powder Coat

Stationary (Ground Sleeve) Benches

73082	8' Bench, Aluminum Finish
73082CXX	8' Bench, Powder Coat
73162	16' Bench, Aluminum Finish
73162CXX	16' Bench, Powder Coat

CUSTOMIZABLE

Powder Coat



*To specify color with order, use the two-digit number of your color selection to replace XX in the item number.



**ALUMINUM STATIONARY
OUTDOOR BLEACHERS**

- Non-Slip, Grooved Type Top Surface With Reinforcing Ribs
- 10" Wide Aluminum Alloy Planks
- Galvanized Structural Steel Support Frames
- Plank Ends Are Fitted With Die-Cut Formed Caps

381083	<i>8' Long, 3 Row</i>
381084	<i>8' Long, 4 Row</i>
381085	<i>8' Long, 5 Row</i>
381163	<i>16' Long, 3 Row</i>
381164	<i>16' Long, 4 Row</i>
381165	<i>16' Long, 5 Row</i>



ALUMINUM TIP & ROLL INDOOR BLEACHERS

Set up seating wherever you need it. When spectator viewing space is at a minimum, the Tip & Roll seating system is a must. The hardy bleachers use the same sturdy construction as the outdoor models.

- Non-Marking 4" Swivel Casters
- Bi-Directional Model Ideal Between Two Fields
- Easy To Transport

379283	<i>8' Long, 3 Row</i>
379163	<i>16' Long, 3 Row</i>



FOOTBALL GOALS

ALUMINUM GOALS

A cleaner look and easier installation that eliminates field drilling.

6 5/8" Gooseneck and crossbar with 4" diameter uprights

8' Gooseneck allows a soccer goal to fit beneath the crossbar

HIGH SCHOOL (23' 4" BETWEEN UPRIGHTS)

COLLEGE (18' 6" BETWEEN UPRIGHTS)

EXPANDABLE (18' 6" TO 23' 4")

6' OFFSET	Ground Sleeve	Plate Mount	Ground Sleeve	Plate Mount	Ground Sleeve	Plate Mount
20' Uprights	FB16120CXX	FB26120CXX	FB16220CXX	FB26220CXX	FB16320CXX	FB26320CXX
30' Uprights	FB16130CXX	FB26130CXX	FB16230CXX	FB26230CXX	FB16330CXX	FB26330CXX
Spliced 30' Uprights	FB16131CXX	FB26131CXX	FB16231CXX	FB26231CXX	FB16331CXX	FB26331CXX
Spliced 35' Uprights	FB16135CXX	FB26135CXX	FB16235CXX	FB26235CXX	FB16335CXX	FB26335CXX
8' OFFSET	Ground Sleeve	Plate Mount	Ground Sleeve	Plate Mount	Ground Sleeve	Plate Mount
20' Uprights	FB18120CXX	FB28120CXX	FB18220CXX	FB28220CXX	FB18320CXX	FB28320CXX
30' Uprights	FB18130CXX	FB28130CXX	FB18230CXX	FB28230CXX	FB18330CXX	FB28330CXX
Spliced 30' Uprights	FB18131CXX	FB28131CXX	FB18231CXX	FB28231CXX	FB18331CXX	FB28331CXX
Spliced 35' Uprights	FB18135CXX	FB28135CXX	FB18235CXX	FB28235CXX	FB18335CXX	FB28335CXX

COLORS



*To specify color with order, use the two-digit number of your color selection to replace XX in the item number.

STEEL GOALS

4 1/2" OD gooseneck, 3 1/2" OD crossbar and 2 3/8" OD uprights.

8' Gooseneck allows a soccer goal to fit beneath the high school crossbar.

20' Uprights	Ground Sleeve	Plate Mount
6' OFFSET	FB36120CXX	FB46120CXX
8' OFFSET	FB38120CXX	FB48120CXX

SOLD SEPARATELY

F39901	Ground Sleeve
F39902	Ground Sleeve - Steel Goals
F35550	Mounting Plate

FOOTBALL STOPPER SET

This football stopper set is designed to keep fans and bystanders safe from field goals and extra points. Installed behind each football goal, the 35' x 50' net can be raised and lowered with ease during a game or stationary during practice. Set includes two stoppers (1 for each goal).

F350



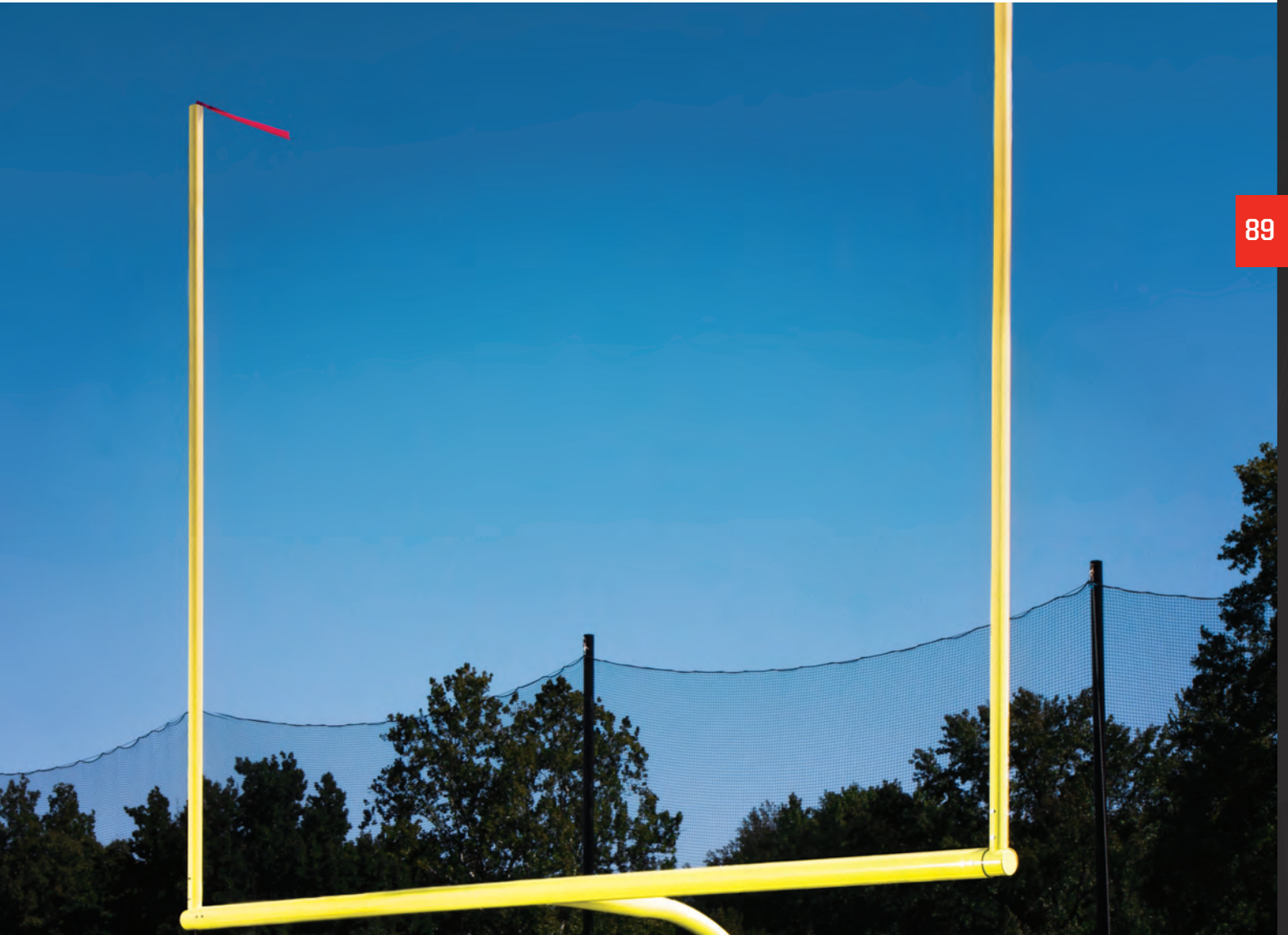

ACCESS FRAME KIT

This kit provides effortless access to the base of a football goal for easy installation, adjustment, or removal. The access frame creates a uniform, seamless surface around the goal post for improved safety. Kit includes access frame and pole plugs that fit around a goal post with a diameter up to 6 5/8". For safety, a solid plug is strongly recommended for use when the goal post is removed. Each goal post requires one kit. Blank metal allows track surface application for continuity in D-Zones.

- F304** *Access Kit - Turf Covered*

- F304S** *Access Kit - Blank Metal*

- F30410** *Access Frame Only*

- F3042** *Pole Plugs - Turf Covered*

- F3043** *Pole Plugs - PVC*

- F3044** *Pole Plugs - Blank Metal*

- F3045** *Solid Plugs - Turf Covered*

- F3046** *Solid Plugs - PVC*

- F3047** *Solid Plugs - Blank Metal*

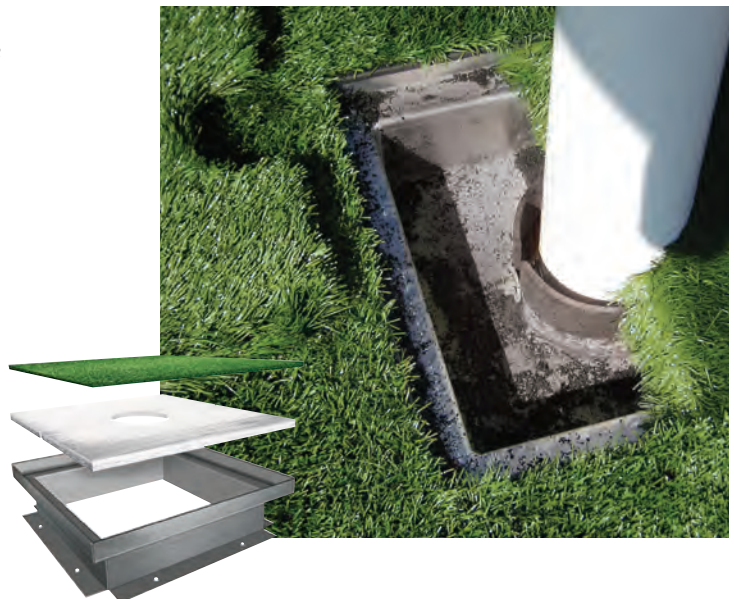

FOOTBALL PADDING



LACE-UP PAD



DELUXE PAD



GOOSENECK PAD

FITS 3½" - 4½" POLE DIAMETERS

Lace-Up Pads: 1½" thick polyurethane foam pad is 6' tall and fits 3½"-4½" pole diameters. 15 oz. vinyl 5'10" x 12" cover available in 14 colors; specify color with order. Lace closure.

000690XX 6' Pad, Lace-Up Pad Closure

000690XXSP 6' Pad, Lace-Up Pad Closure with Graphics

068CXX Vinyl Lace Cover

FITS 4½" - 5 5/16" POLE DIAMETERS

Deluxe Pad: 4" thick polyurethane foam pad is 6' tall and fits 4½"- 5 5/16" pole diameters. 15 oz vinyl cover available in 14 colors. Hook and loop closure. Graphics available with new pad.

001870XX 6' Pad, Hook-And-Loop Closure

001870XXSP 6' Pad, Hook-And-Loop Closure, With Graphics

CUSTOMIZABLE



*To specify color with order, use the two-digit number of your color selection to replace XX in the item number.

FITS 6" - 8" POLE DIAMETERS

Gooseneck Pad: 6" thick polyurethane padding covered in tough 15oz vinyl available in 14 colors (specify color when ordering). Already have the pad? Choose the F299XX custom graphic wrap which is printed on a separate vinyl full-size sheet that covers the F302 pad for a whole new look.

F302XX 6' Gooseneck Pads, Hook-And-Loop Closure

F302XXSP 6' Gooseneck Pads with Graphics

F299XX Graphic Vinyl Wrap (Covers 1 Existing Pad)



FOOTBALL PYLONS

- Bottom Weighted markers (require no additional hardware to install)
- Meets NCAA & NFHS Requirements

296801 Pylons (set of 4)

SPECIALTY GOALS



STEEL H-STYLE FOOTBALL/RUGBY GOALS

- Uprights And Crossbar Constructed of 3½" Steel Tube
- Durable white or optic yellow powder coat finish

RUGBY/COLLEGIATE/PRO GOALS (18' 6" BETWEEN UPRIGHTS)

281181CXX Goals, 10' uprights

281182CXX Goals, 20' uprights

HIGH SCHOOL GOALS (23' 4" BETWEEN UPRIGHTS)

281231CXX Goals, 10' uprights

281232CXX Goals, 20' uprights

COLORS



*To specify color with order, use the two-digit number of your color selection to replace XX in the item number.



COMBINATION FOOTBALL/SOCCER GOALS

- Football uprights can be secured at 23'4" or 18'6" widths or removed for soccer play. Constructed of 4"x 2" steel tube with 2" square steel tube uprights that extend 10' above crossbar. Soccer nets/backstays sold separately. Soccer goal is 8' x 24' x 8'.
- Meets high school specs for football/soccer
- Durable white powder coat finish

00274000 Combination Goal

SOLD SEPARATELY

00424000 Required Ground Sleeve

00491824 Net For Use with Backstay (pair)

00291000 Standard Backstay (Set of 4)

292300 European Backstay (Set of 4)



CROSSOVER ZONE®

For everyday use, the Crossover zone is lighter and easier to handle than other conveyor belt rubber systems. Protects against steel tipped cleats, shoes and even grounds equipment wheels, yet rain drains through. Black geotextile with gold edging for safety and durability.

493663 15' x 30' Zone

493664 15' x 40' Zone

493651 15' x 75' Zone

493652 15' x 100' Zone

493653 15' x 125' Zone

493667 7.5' x 30' Zone

493668 7.5' x 40' Zone

U90 WORLD CUP & PORTABLE GOALS

92



upper90¹

MEETS FIFA, NCAA, & NFHS

U90 STATIONARY WORLD CUP GOAL

8' x 24' goals made of 4" round aluminum construction in a white powder coat finish.

492200 *World Cup Goal Package*

INCLUDED: 8' x 24' Goals (pair), White Hexagon Nets (pair), Ground Sleeves (4), Back Post Net Supports (4), Back Post Ground Sleeves (4), Net Tie Down Stakes (16)

GET CLASSIC **WORLD CUP** STYLE ANYWHERE!

SOCCER



Upper90¹

MEETS FIFA, NCAA, & NFHS

U90 PORTABLE WORLD CUP GOAL

Portable 8' x 24' goals made of 4" round aluminum construction that comes in a white powder coated finish with custom powder coated back posts. Goal nests under 8' football goal posts. Sold in pairs.

493000CXX *World Cup Portable Goal Package*

INCLUDED: 8' x 24' Goals (pair), White Hexagon Nets (pair), 4 Easy-To-Engage Wheel Assemblies, Auger Anchor Kit, Back Bar with Weights

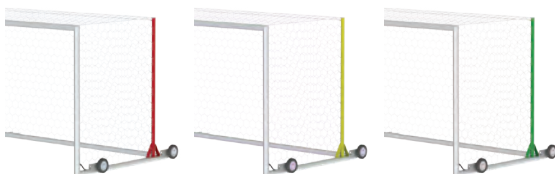

CUSTOMIZABLE

- | | | | | | | | | | | | | | | |
|------------|------------|-----|-------|--------|-------------|--------|----------|------|--------|--------|-------|-----------|-------------|------------|
| 01 | 02 | 03 | 04 | 05 | 06 | 07 | 08 | 09 | 10 | 11 | 12 | 13 | 14 | 15 |
| LIGHT BLUE | ROYAL BLUE | RED | WHITE | ORANGE | YELLOW GOLD | SILVER | OLD GOLD | GRAY | MAROON | PURPLE | BLACK | NAVY BLUE | KELLY GREEN | DARK GREEN |

**To specify color with order, use the two-digit number of your color selection to replace XX in the item number.*

U90 PREMIER PORTABLE GOAL

94



MEETS FIFA, NCAA, & NFHS

U90 PREMIER PORTABLE GOAL

Portable goals made of 4" round aluminum construction that comes in a white powder coated finish. Equipped with European backstays and signature Upper90 lift and roll wheels.

587200	8' x 24' Premier Package
587202	8' x 24' Premier Nesting Package
587203	6' 6" x 18' 6" Premier Package

*INCLUDED: Goals (pair), 3mm x 5" Square Braid Net / White (pair), Quick Clip Net System
4 Easy-To-Engage Wheel Assemblies, Auger Anchor Kit, Back Bar with Weights*



CHAMPIONSHIP GOAL



MEETS FIFA, NCAA, & NFHS

U90 CHAMPIONSHIP PORTABLE GOAL

Portable goals made of 4" round aluminum construction that comes in a white powder coated finish. Equipped with European backstays and signature Upper90 lift and roll wheels. A variety of net styles are available.

48713 8'x24' Championship Package

*INCLUDED: 8' x 24' Goals (pair), Nets (pair), Transport Kit (pair)
Auger Anchor Kit, Back Bar with Weights*

487200 8' x 24' Championship Goals

INCLUDED: 8' x 24' Goals (pair), Auger Anchor Kit, Rear Spreader Tube Kit

Accessories

00293000 Transport Kit



ANCHORS & SLEEVES

AUGER ANCHOR KIT

Auger-type goal anchor kit (set of 4) is required on existing portable soccer goals for maximum player safety. Wraps around backstay tubing and through auger to prevent tipping.

00298170



GOAL ANCHORING SYSTEM

Latches around the base of football goal gooseneck and connects to the rear spreader bar of goal. Simple system guards against soccer goal tip over.

F155



SEASONAL ANCHOR SYSTEM

Install aluminum tube anchors in concrete and bolt goal to anchor through the backstay tube. Seasonal/semi-permanent kit includes 8 anchors for securing 2 soccer goals.

00417040 *Set of 4 Anchors*



OUTDOOR GROUND SLEEVES

In-ground/sleeve style soccer goals are the best choice for providing maximum safety! Sold individually.

00402000 *Fits 2 3/8" Back Posts*

00404000 *Fits 4" Round Goals*

404570 *4" Round Sleeve Cover (4 pack)*

00424000 *Fits 4" x 2" Goals*



REPLACEMENT WARNING LABELS

LABL00552000 *Portable*

LABL00553000 *Stationary*



GROUND SLEEVE ANCHOR

A ground sleeve option for securing portable goals in turf fields. Featuring a small 4 1/2" footprint and a flexible top that compresses with surrounding turf on impact. Chain link wraps anchor pin inside ground sleeve and rear spreader tube on surface to secure goal in place. Padlocks included. Cap may be covered with turf for uniform appearance.

00406



5' FIELD FLAGS

54601 *Set of 8, Numbered 1-8, Steel Peg*

54604 *Set of 4 Corner Flags, Steel Peg*

54603 *Set of 4 Corner Flags, 7" Rubber Base*

LACROSSE & FIELD HOCKEY



LACROSSE GOALS

Portable goals are made of 1 7/8" aluminum round tubing and snap together for quick assembly.

263300 Portable Goals

6' X 6' PORTABLE LACROSSE GOALS

Single goal that's easy to assemble with lightweight 1 1/2" bright orange powder coated aluminum. Folds flat for storage. Includes UV-resistant white net.

54514 Portable Goal

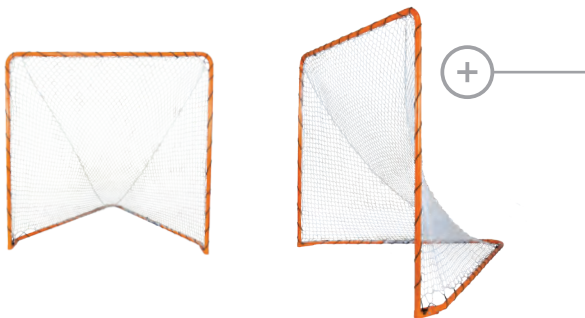

PRACTICE FUTSAL GOAL

Portable 6'7" x 9'10" goals made of 3" round aluminum powder coated finish. Includes 4mm white nets and easy to engage wheels. Sold as pair.

54515



COMPETITION FIELD HOCKEY GOALS

7' x 12' x 4' stationary goals feature 1 7/8" square heavy wall structural steel construction in white powder coated finish. Uses official 18" bottom boards and includes weather-treated 1 1/2" square nets (#21 nylon).

260100

SOLD SEPARATELY

260101 Transport System (Fits 1 Goal)

Includes (2) pneumatic tires and support bracket assemblies. Attaches to back of a single field hockey goal so user can tip and roll the goal on and off the field.

TENNIS

98



ELITE TENNIS POSTS

Competition tennis posts with fully enclosed net tensioning mechanism. 4" square high strength aluminum posts with heavy duty outdoor powder coating. Post cap with tamper resistant hardware to prevent vandalism or use by unauthorized individuals. Includes one winch post and one tie-off post. Ground sleeves, net, and accessories all sold separately.

885 *Dark Green Posts*

SOLD SEPARATELY

- 00444000** *Outdoor Ground Sleeve, Square Cover*
- 00885800** *Indoor Floor Sleeve, Chrome Cover*
- 00885900** *Indoor Floor Sleeve, Brass Cover*



ESSENTIALS TENNIS POSTS

Competition tennis posts with fully enclosed net tensioning mechanism. Outdoor system includes ground sleeves. Indoor system requires purchase of floor sleeves. 3.5" OD high strength steel posts with heavy duty dark green outdoor powder coating. Net and accessories are sold separately.

- 884** *Outdoor Posts*
- 884A** *Indoor Posts*

SOLD SEPARATELY

- 2235** *Tennis Net 42' x 39"*
- 00885500** *Singles Stick Net Support*
- 02238000** *Center Tie Down Strap*
- 02239000** *Outdoor Center Strap Anchor*
- 02238100** *Indoor Center Strap Anchor*
- 02991340** *Indoor Tennis Net 34' x 39"*
- 010970XX** *Indoor Tennis Pads*



TENNIS BENCH

See page 86

WINDSCREENS

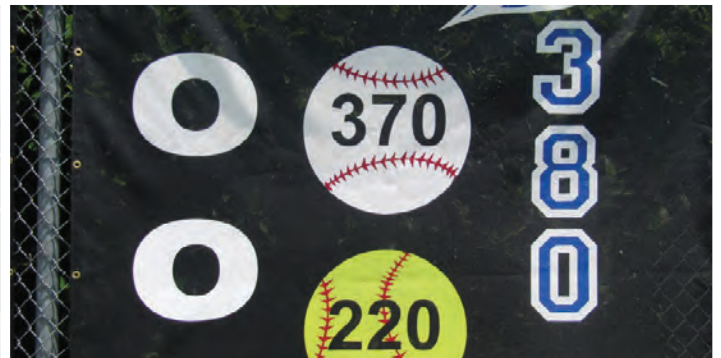

TUFFY® WINDSCREENS

Screens are made with an exclusive durable mesh fabric of tightly woven micro-fibers: it's virtually tear-proof. Tuffy® is the only windscreen finished with double-needle lock stitching, eliminating the thread unraveling problem of traditional windscreens. Includes 5 year warranty, available in 20 colors. Grommets every 12". 78% Shading. Custom Printing available - call for details.

- 912014 *Tuffy® 4' Windscreen, Per Linear Foot*

- 912015 *Tuffy® 5' Windscreen, Per Linear Foot*

- 912016 *Tuffy® 6' Windscreen, Per Linear Foot*

- 912019 *Tuffy® 9' Windscreen, Per Linear Foot*

- 912065 *6' x 5' Ballasted Tuffy® Windscreen*

AER-FLO VCP® WINDSCREENS

Made for 8 oz. vinyl coated polyester mesh with double lock-switch sewn ends/corners. Grommets every 12"; available in Black, Dark Green, Navy, Royal Blue, Red, or Maroon. Includes 2 year warranty. 70% shade. Custom printing available - call for details.

- 912026 *VCP 6' Windscreen, Per Linear Foot*

- 912029 *VCP 9' Windscreen, Per Linear Foot*

LENO WINDSCREENS

Made of leno polypropylene mesh. Reinforcing threads resist tearing, features ultraviolet and mildew inhibitors. Allows 15% wind passage; popular in high wind areas. Available in Dark Green, Black, or Royal, printing not available on this fabric.

- 912036 *LENO 6' Windscreen, Per Linear Foot*

- 912039 *LENO 9' Windscreen, Per Linear Foot*

CLOSED MESH POLY WINDSCREENS

Allowing only 8% wind passage, this screen has both high wind blockage and high visual blockage properties. Heavyweight polypropylene fabric is treated for UV, mildew, and insect resistance. Available in Dark Green or Black, grommets every 18". Air vents and tie downs are recommended. Printing not available on this fabric.

- 912046 *6' Poly Closed Mesh Windscreen, Per Linear Foot*

- 912049 *9' Poly Closed Mesh Windscreen, Per Linear Foot*

CLOSED MESH POLY WINDSCREENS

- 912051 *Homerun Zone Windscreen Topper, Per Linear Foot*

- 912071 *Hemmed Windscreen 6" x 12" Window*

- 912081 *Rectangular Windscreen 6" x 12" Air Vent*

BASEBALL

100



CANTILEVER DUGOUT

8' tall x 8' wide cantilever dugout with 24" rear offset. Bolt together design with a 120 MPH wind rating and 50 lb/sq ft snow rating. Choose from 15 different powder coat colors. Roof only available in white.

340812CXX	12' Long
340824CXX	24' Long
340836CXX	36' Long
340848CXX	48' Long

FIELD SHELTER DUGOUT

8' tall x 8' wide. Bolt together design with a 120 MPH wind rating and 50 lb/sq ft snow rating. Choose from 15 different powder coat colors. Roof only available in white.

330812CXX	12' Long
330824CXX	24' Long
330836CXX	36' Long
330848CXX	48' Long

CUSTOMIZABLE DUGOUTS

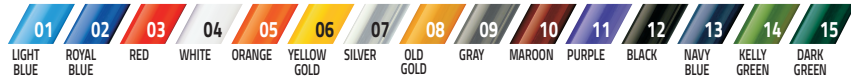

*To specify color with order, use the two-digit number of your color selection to replace XX in the item number.

MAJOR LEAGUE HOME PLATE

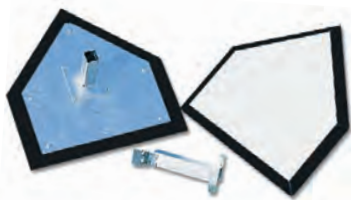

Sturdy hard rubber base designed to withstand the battering of cleats. Runners sliding into home won't dislodge the base thanks to the included anchor, while the beveled edges prevent cleats or uniforms from snagging during the slide.

33250

MAJOR LEAGUE SHOCK ABSORBING BASES



Cushioned base designed to help reduce injury. Durable, one-piece molded rubber base with no metal parts. Removable white center post for easy storage and replacement. Does not include anchors.

33251 Set of 3 Bases

33253 White Center Posts (3)

4-WAY PITCHERS RUBBER



Molded rubber construction with inner support tubing lasts through tough games and practices. Can be periodically rotated for use over multiple seasons.

33252 Pitchers Rubber

GROUND ANCHOR SET

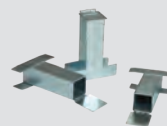

33254 Ground Anchors (3)

BASE PLUGS



33255 Base Plugs (3)

FOUL POLES

BASEBALL FOUL POLES

Baseball foul poles extend the foul lines vertically to provide a visual indication of the fair versus foul territory. Made of two sections that bolt together in the field, constructed of heavy-duty steel pipe. Available in 5 heights, sold in pairs in a durable powder coat finish.

- 8' wing panels
- Available in optic yellow (18), white (04) and optic orange (24)
- GSMIF (ground sleeve miss installation forgiveness)

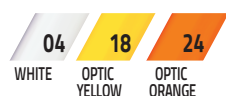

*To specify color with order, use the two-digit number of your color selection to replace XX in the item number.

In-Ground/Sleeved:

334012CXX	12', No Wings
334016CXX	16', 1 Wing
334024CXX	24', 2 Wings
334032CXX	32', 3 Wings
334040CXX	40', 4 Wings

Surface Mount

334116CXX	16', 1 Wing
334124CXX	24', 2 Wings
334132CXX	32', 3 Wings
334140CXX	40', 4 Wings

Ground Sleeves

00402000	For 12'
F39903	For 16'
F39903	For 24'
F39901	For 32'
F39901	For 40'

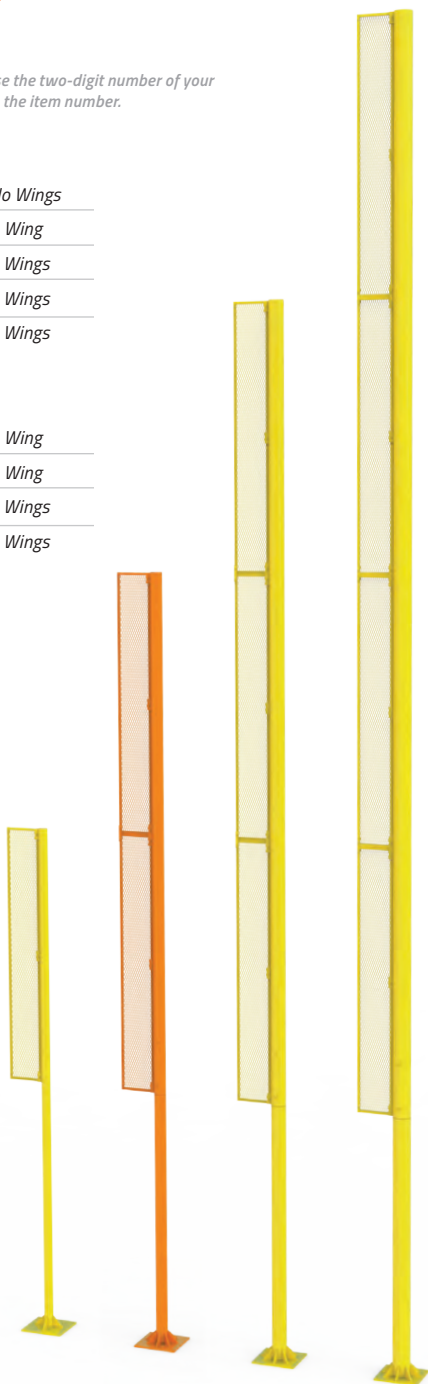

porter
FEATURING

GILL
ATHLETICS

**MAKING GREAT
EQUIPMENT
ISN'T EASY.
INSTALLING
IT SHOULD BE.**

Since 1918, Gill Athletics® has been equipping coaches with innovative equipment that elevates the sport and performance of athletes across the globe.

OUTDOOR PADDING

102



Essentials Outdoor Wall & Fence Pads

2" thick polyurethane foam core attached to 1/2" thick, sealed, water resistant PVC. Pad meets the minimum ASTM F2440 impact standard specification. Each panel uses 15oz UV treated vinyl. **WALL PAD** panels have an unwrapped back. **FENCE PAD** panels are completely wrapped, using threaded wood inserts to allow for chain link fence attachment. All pads can also be installed using "Z" clips allowing seasonal removal, repair, or replacement. All Pads built to your specified dimensions with a maximum width of 4'. Custom Graphics available (add **SP** to end of item #).

Custom Graphics Available for Essentials and Elite Pads (Additional Charge) **Add SP to end of item #**

Elite Outdoor Wall & Fence Pads

3" thick polyurethane foam core attached to 1/2" thick, sealed, water resistant PVC. Pad meets the minimum ASTM F2440 impact standard specification. Each panel uses 19oz UV treated vinyl. **WALL PAD** panels have an unwrapped back. **FENCE PAD** panels are completely wrapped, using threaded wood inserts to allow for chain link fence attachment. All pads can also be installed using "Z" clips allowing seasonal removal, repair, or replacement. All Pads built to your specified dimensions with a maximum width of 4'. Custom Graphics available (add **SP** to end of item #).

WALL PADS	FENCE PADS	
36202XX	36402XX	4' x 2' Pad
9036202XX	9036402XX	Custom Size - 4' x 2' or less
36204XX	36404XX	4' x 4' Pad
9036204XX	9036404XX	Custom Size - 4' x 4' or less
36206XX	36406XX	4' x 6' Pad
9036206XX	9036406XX	Custom Size - 4' x 6' or less
36208XX	36408XX	4' x 8' Pad
9036208XX	9036408XX	Custom Size - 4' x 8' or less

WALL PADS	FENCE PADS	
36302XX	36502XX	4' x 2' Pad
9036302XX	9036502XX	Custom Size - 4' x 2' or less
36304XX	36504XX	4' x 4' Pad
9036304XX	9036504XX	Custom Size - 4' x 4' or less
36306XX	36506XX	4' x 6' Pad
9036306XX	9036506XX	Custom Size - 4' x 6' or less
36308XX	36508XX	4' x 8' Pad
9036308XX	9036508XX	Custom Size - 4' x 8' or less

Essentials Vinyl



Use the two-digit number of your color selection to replace XX in the item number.

WALL ATTACH Z-CLIPS

347100 6' Wall Attachment Clip

Elite Vinyl



Use the two-digit number of your color selection to replace XX in the item number.



Hexagon Pole Pad

6-sided pad fits pole diameters from 10" minimum up to maximum of 24". Pad has a maximum height of 8" tall and is constructed using 15oz UV resistant vinyl.

90616XX Custom Size Pad

Vinyl



Use the two-digit number of your color selection to replace XX in the item number.



Fence Toppers

An inexpensive way to outline the perimeter of your ballpark and reduce player injuries by adding protection and clear visibility. Constructed of bright yellow 4" diameter rigid corrugated plastic tubing. Pre-split for use with install tool for easier installation. Weather treated and UV protected to last the test of time. Adds a professional quality appearance on every game day. Optional installation tool and UV resistant cable ties available.

332F106 100' Length

332F256 250' Length

332F3 Installation Tool

332F4 19" Cable Ties, Set of 100



Rail Padding

8' long pads are polyethylene foam with colored vinyl coating. UV, weather and rot resistant pads are pre-slit for easy installation. Fits over any 2½" diameter or less pipe.

35901 Light Blue

35903 Red

35906 Yellow

35909 Gray

35912 Black

35913 Navy

35914 Green



Fence Padding Kit

Designed to pad the top rail of woven wire fence and minimize injuries to players during outdoor activities.

Pads consist of shock absorbing, closed cell weather resistant polyethylene foam and a polyester reinforced cover with grommets and durable nylon, self-locking type wire ties. Kit is provided in 9 slit sections of 31/2" O.D. x 2" I.D. foam in 28" lengths. The cover is one 20' section, which may be easily cut to provide custom lengths when required. Standard is yellow, available in 14 colors.

003581XX 20' Padding

OUTDOOR TUNNELS & CAGES

104



Batting Tunnels

SINGLE

330155 55' long
330175 75' long

DOUBLE

330255 55' long
330275 75' long

TRIPLE

330355 55' long
330375 75' long

- ✔ Heavy duty 8⁵/₈" OD steel poles
- ✔ Premium architectural black powder coating
- ✔ Four steel pole, open-cage design creates an open cage and hanging net so balls stop without rebound
- ✔ 1/4" galvanized aircraft quality cable
- ✔ Easy turnbuckle adjustment, and quick clip (snap hook) net attachment
- ✔ #36 weather treated knotted netting, machine sewn stitched rope borders, top center rib line for height control, and double door entry on one end



Batting Cages

The cage is 10' high x 12' wide and available in either a 50' or 70' length. Netting is constructed of a durable, black UV resistant weather treated nylon with a 1³/₄", #420 square mesh. The net is supported by 2⁷/₈" diameter aluminum uprights to provide lightweight, yet extremely rigid supports. Uprights extend into either outdoor or indoor sleeves and are furnished with ropes, pulleys, and rope cleats to provide ease of set up of the entire system without the use of ladders.

330150 50' Cage (8 Sleeves Required)
330170 70' Cage (10 Sleeves Required)
802025 Outdoor Ground Sleeve (1)

WHEN FAST MATTERS

For facilities hosting multiple back-to-back events, the NEW Porter RAPIDLIFT® winch can help turnover the next activity up to 3x as fast.

See page 62.

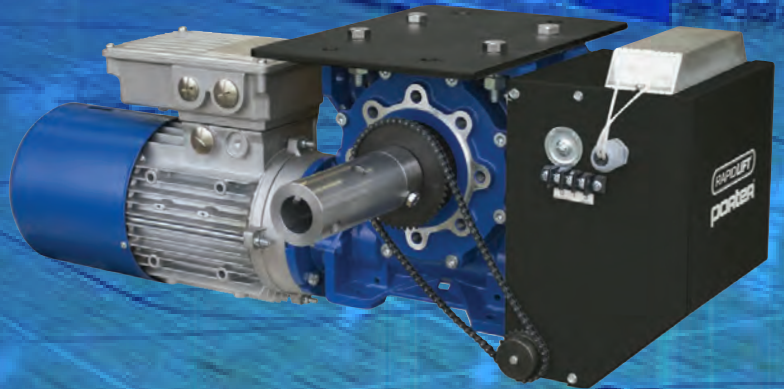

Contract #071819-PTA

Sourcewell (formerly NJPA) creates national cooperative contract purchasing opportunities and solutions on behalf of its members which include all government, education and non-profit agencies nationwide. These cooperative contract purchasing opportunities present both time and money savings for users.



WWW.GILLPORTER.COM/PORTER/DEALER-LOCATOR

Keeping your athletic equipment in safe and working order is crucial for any facility. Yearly inspections should take place on all ceiling suspended equipment and safety equipment to keep it safe and in working order. Ensure your equipment is checked out by a Porter authorized inspector.

2023 EQUIPMENT

COLLECTION CATALOG



porter®

FACILITIES BASKETBALL VOLLEYBALL SOCCER FOOTBALL

PORTERATHLETIC.COM

601 MERCURY DRIVE | CHAMPAIGN, IL 61822

800.523.5177

PORTER@PORTERATHLETIC.COM